

#	Revision	Date

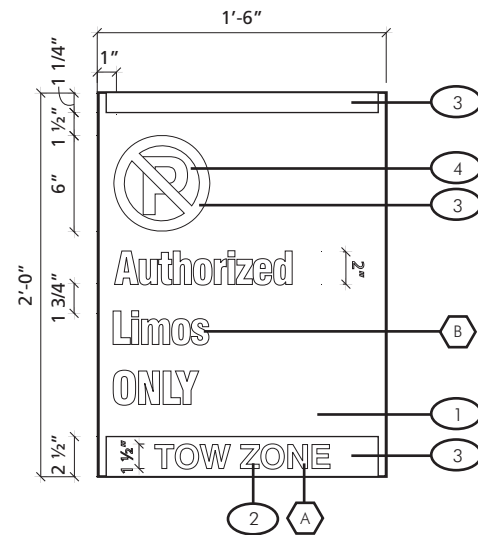

SIGN FACE LAYOUT  
Scale: 3/4" = 1'-0"

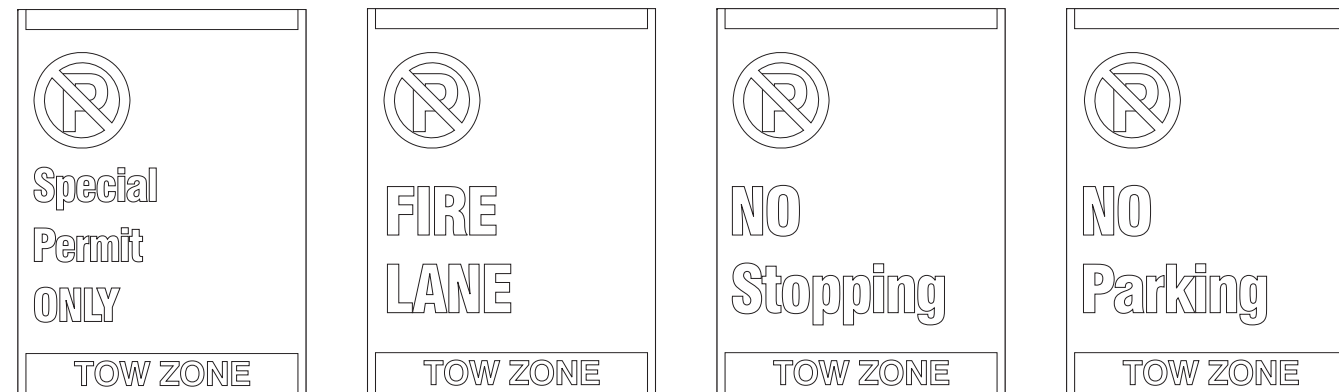

SIGN FACE ALTERNATE LAYOUTS  
Scale: 3/4" = 1'-0"

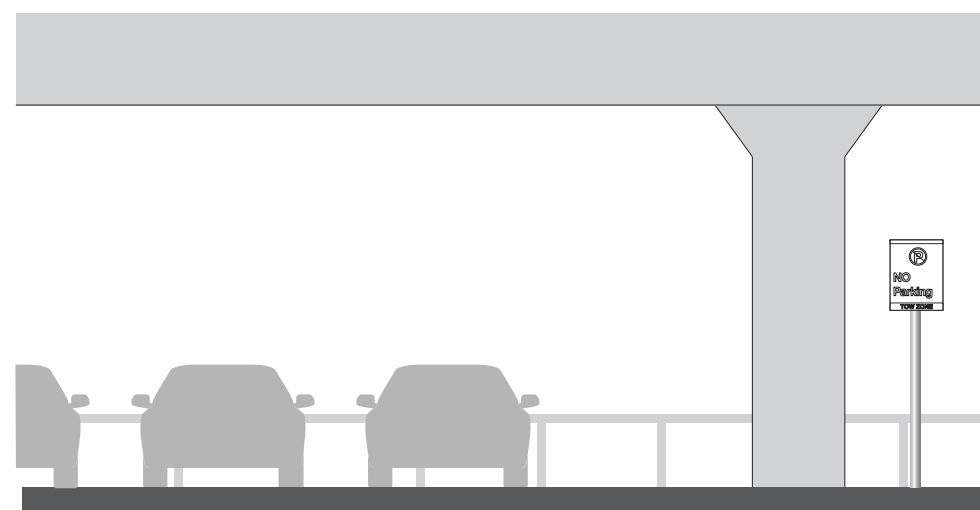

ELEVATION  
Scale: N.T.S.

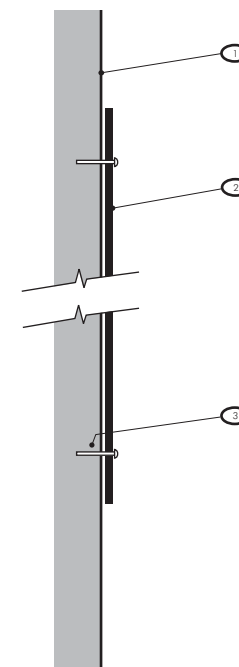

DETAIL  
Scale: N.T.S.

**Post Mount - Informational ST - 381**

DESCRIPTION: Parking Regulatory

LOCATION: Used in and around parking garage areas.

MATERIALS: Fabricated stainless steel panel with vinyl graphics.

LETTERING:  
 A Swiss721 BT Bold  
 B Swiss721 BlkCn BT Bold

SYMBOLGY: Refer to Section 2.2.2

COLORS:  
 1 Background: 3M Opaque Film #7725-12 or approved equal (Black)  
 2 Text: 3M Opaque Film #220-10 or approved equal (White)  
 3 Band: 3M Opaque Film #220-13 or approved equal (Red)  
 4 Symbol: 3M Opaque Film #220-10 or approved equal (White)  
 5 Arrow: 3M Opaque Film #220-10 or approved equal (White)  
 6 Terminal I.D.:  
 Terminal A 3M#230/230-127 (Intense Blue)  
 Terminal B 3M#230/230-33 (Red)  
 Terminal C 3M#230/230-26 (Green)  
 Terminal D 3M#220-98 (Dark Violet)  
 7 Arrow circle: 3M Opaque Film (dark Gray) #7725-41

GRAPHICS: N/A

ARROWS: N/A

MOUNTING: Post Mounted.

ILLUMINATION: Sign will be Non Illuminated.

REMARKS: Refer to Section 2.5 for vinyl specifications

NOTES:

- 1 Wall surface (varies); wood barriers, metal panels, or posts.
- 2 Aluminum panel, mounted on various wall surfaces with bolts punctured through the panel surface.
- 3 When applicable, drill only into mortar joints avoiding solid masonry faces.

Use mounting plate if necessary for variable wall conditions.

**Informational Signs - Vehicular 3.5.1**



#	Revision	Date

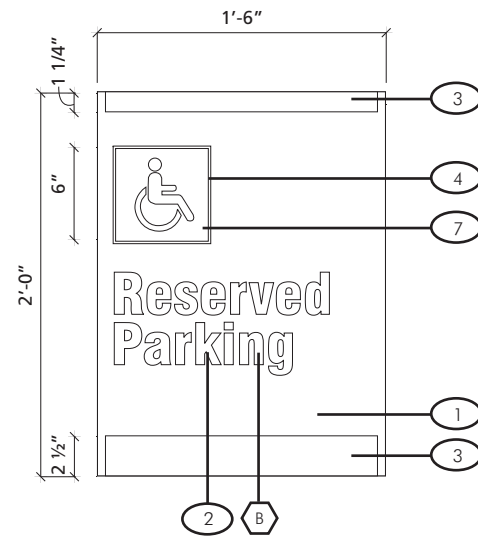

SIGN FACE LAYOUT  
Scale: 3/4" = 1'-0"



SIGN FACE ALTERNATE LAYOUTS  
Scale: 3/4" = 1'-0"

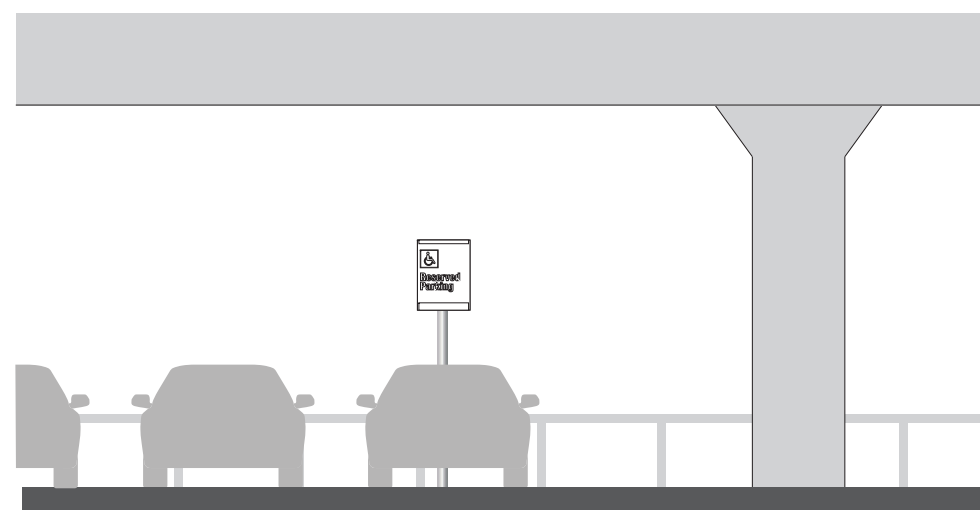

ELEVATION  
Scale: N.T.S.

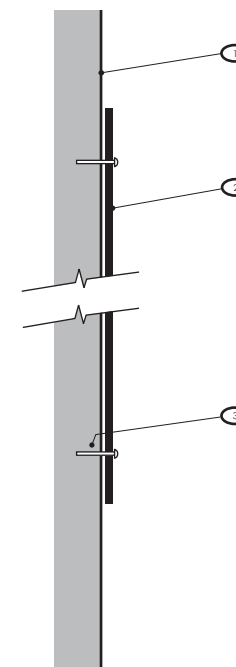

DETAIL  
Scale: N.T.S.

**Post Mount - Informational ST - 382**

DESCRIPTION: Handicap Regulatory

LOCATION: Used in and around parking garage areas.

MATERIALS: Fabricated stainless steel panel with vinyl graphics.

LETTERING:  
 A Swiss721 BT  
 B Swiss721 BlkCn BT

SYMBOLGY: Refer to Section 2.2.2

COLORS:  
 1 Background: 3M Opaque Film #7725-12 or approved equal (Black)  
 2 Text: 3M Opaque Film #220-10 or approved equal (White)  
 3 Band: 3M Opaque Film #220-13 or approved equal (Red)  
 4 Symbol: 3M Opaque Film #220-10 or approved equal (White)  
 5 Arrow: 3M Opaque Film #220-10 or approved equal (White)  
 6 Terminal I.D.:  
 Terminal A 3M#230/230-127 (Intense Blue)  
 Terminal B 3M#230/230-33 (Red)  
 Terminal C 3M#230/230-26 (Green)  
 Terminal D 3M#220-98 (Dark Violet)  
 7 Symbol Background: 3M Opaque Film #220-47 or approved equal (Blue)

GRAPHICS: N/A

ARROWS: N/A

MOUNTING: Post Mounted.

ILLUMINATION: Sign will be Non Illuminated.

REMARKS: Refer to Section 2.5 for vinyl specifications

NOTES:

- 1 Wall surface (varies); wood barriers, metal panels, or posts.
- 2 Aluminum panel, mounted on various wall surfaces with bolts punctured through the panel surface.
- 3 When applicable, drill only into mortar joints avoiding solid masonry faces.

Use mounting plate if necessary for variable wall conditions.

**Informational Signs - Vehicular 3.5.1**



#	Revision	Date

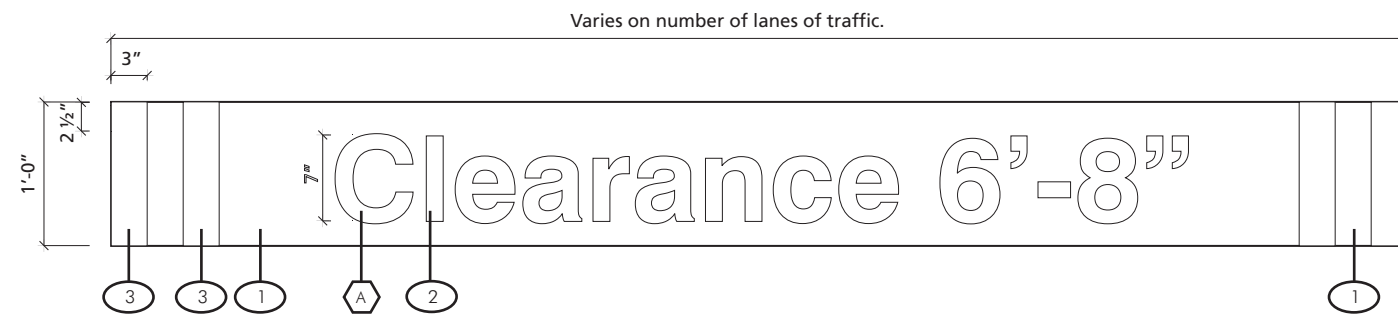

SIGN FACE LAYOUT

Scale: 3/4" = 1'-0"

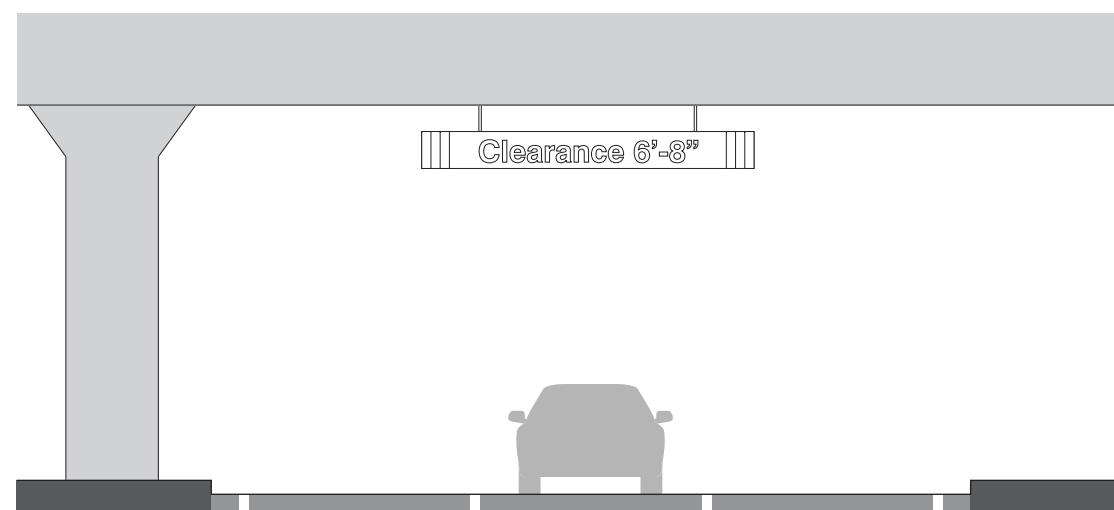

ELEVATION

Scale: N.T.S.

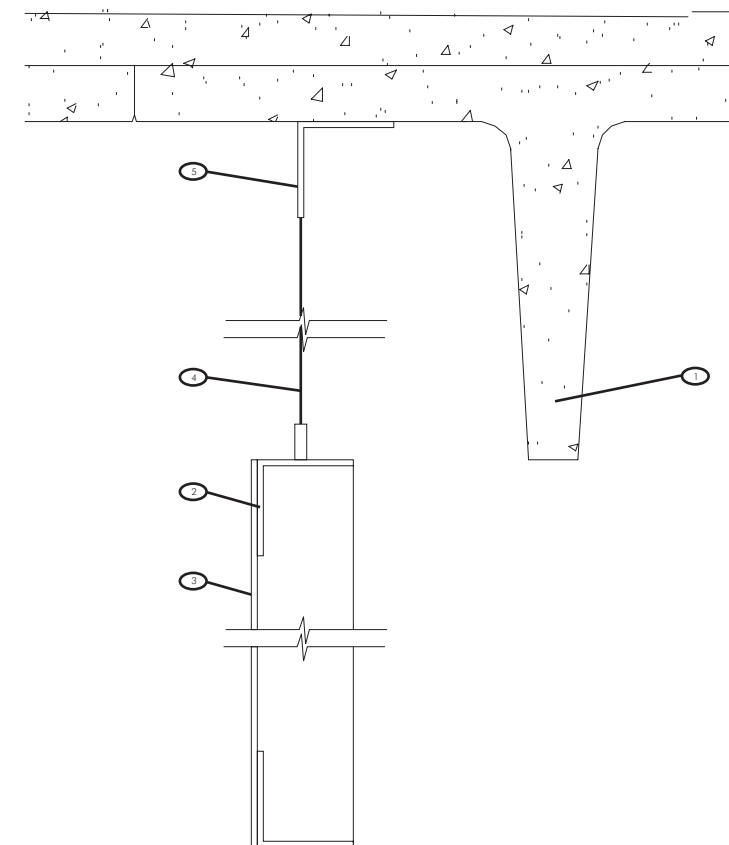

HANGING DETAIL

Scale: N.T.S.

**Overhead - Informational ST - 383**

DESCRIPTION: Vehicular Clearance ID

LOCATION: Overhead to delineate height clearance for vehicular traffic.

MATERIALS: Fabricated stainless steel panel.

LETTERING:  
 (A) Swiss721 BT Bold  
 (B) N/A

SYMBOLGY: N/A

COLORS:  
 (1) Background: 3M Opaque Film #7725-12 or approved equal (Black)  
 (2) Text: 3M Opaque Film #220-10 or approved equal (White)  
 (3) Band: 3M Opaque Film # 220-45 or approved equal (Yellow)  
 (4) Symbol: 3M Opaque Film #220-10 or approved equal (White)  
 (5) Arrow: 3M Opaque Film #220-10 or approved equal (White)  
 (6) Terminal I.D:  
 Terminal A 3M#230/230-127 (Intense Blue)  
 Terminal B 3M#230/230-33 (Red)  
 Terminal C 3M#230/230-26 (Green)  
 Terminal D 3M#220-98 (Dark Violet)  
 (7) Arrow circle: 3M Opaque Film (dark Gray) #7725-41

GRAPHICS: N/A

ARROWS: N/A

MOUNTING: Ceiling suspended.

ILLUMINATION: Sign will be Non Illuminated.

REMARKS: Refer to Section 2.5 for vinyl specifications

NOTES:

- (1) Existing reinforced concrete structure.
- (2) 2" "L" bracket support. Weld attach to sign face.
- (3) 1/8" aluminum sign face.
- (4) 1/8" cable.
- (5) 2" "L" bracket. Hilti anchor attach to reinforced concrete structure.

**Informational Signs - Vehicular 3.5.1**



#	Revision	Date

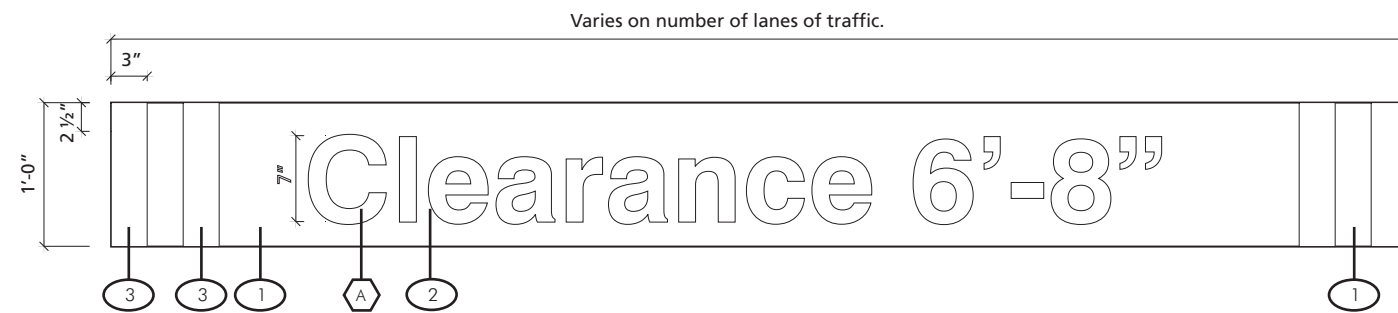

SIGN FACE LAYOUT

Scale: 3/4" = 1'-0"

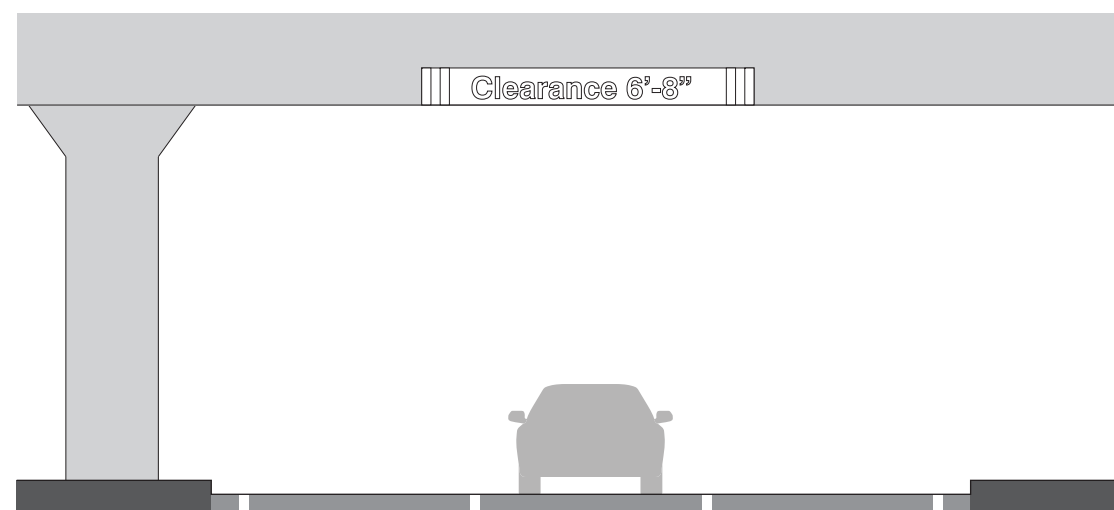

ELEVATION

Scale: N.T.S.

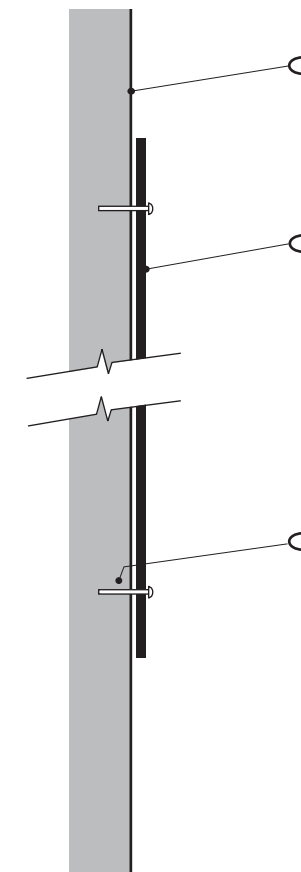

DETAIL

Scale: N.T.S.

**Overhead - Directional** **ST - 384**

DESCRIPTION: Vehicular Clearance ID

LOCATION: Overhead to delineate height clearance for vehicular traffic.

MATERIALS: Fabricated stainless steel panel.

LETTERING:  
 A Swiss721 BT Bold  
 B N/A

SYMBOLGY: Refer to Section 2.2.2

COLORS:  
 1 Background: 3M Opaque Film #7725-12 or approved equal (Black)  
 2 Text: 3M Opaque Film #220-10 or approved equal (White)  
 3 Band: 3M Opaque Film # 220-45 or approved equal (Yellow)  
 4 Symbol: 3M Opaque Film #220-10 or approved equal (White)  
 5 Arrow: 3M Opaque Film #220-10 or approved equal (White)  
 6 Terminal I.D:  
 Terminal A 3M#230/230-127 (Intense Blue)  
 Terminal B 3M#230/230-33 (Red)  
 Terminal C 3M#230/230-26 (Green)  
 Terminal D 3M#220-98 (Dark Violet)  
 7 Arrow circle: 3M Opaque Film (dark Gray) #7725-41

GRAPHICS: N/A

ARROWS: N/A

MOUNTING: Soffit Mounted.

ILLUMINATION: Sign will be Non Illuminated.

REMARKS: Refer to Section 2.5 for vinyl specifications

NOTES:

- 1 Wall surface (varies); wood barriers, metal panels, or posts.
- 2 Aluminum panel, mounted on various wall surfaces with bolts punctured through the panel surface.
- 3 When applicable, drill only into mortar joints avoiding solid masonry faces.

Use mounting plate if necessary for variable wall conditions.

**Informational Signs - Vehicular** **3.5.1**



#	Revision	Date

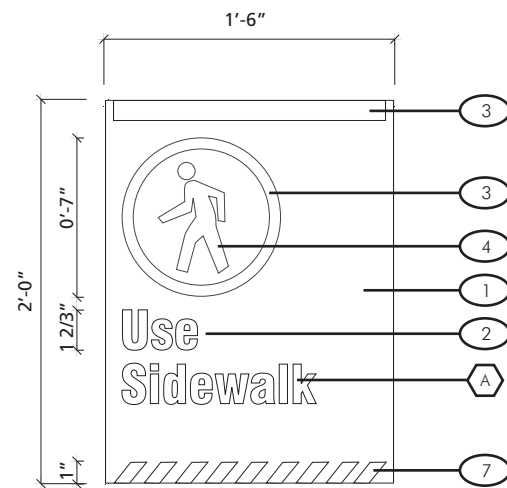

SIGN FACE LAYOUT  
Scale: 3/4" = 1'-0"

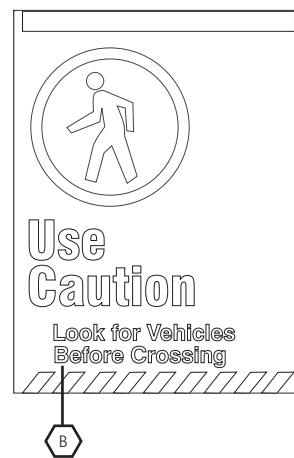

SIGN FACE ALTERNATE LAYOUT  
Scale: 3/4" = 1'-0"

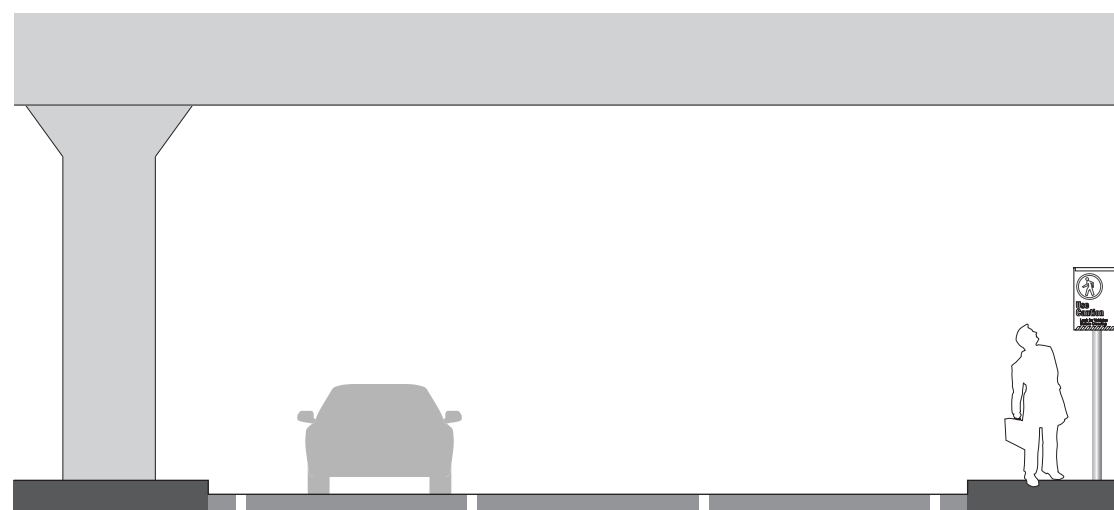

ELEVATION  
Scale: N.T.S.

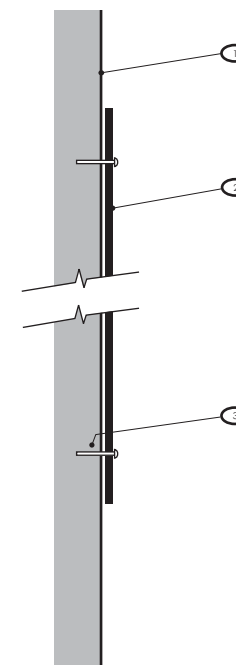

DETAIL  
Scale: N.T.S.

**Post Mount - Informational ST - 391**

DESCRIPTION: Pedestrian Regulatory

LOCATION: Used in and around parking garages areas.

MATERIALS: Fabricated stainless steel panel with vinyl graphics.

LETTERING:  
 A Swiss721 BlkCn BT  
 B Swiss721 BT Bold

SYMBOLGY: Refer to Section 2.2.2

COLORS:  
 1 Background: 3M Opaque Film #7725-12 or approved equal (Black)  
 2 Text: 3M Opaque Film #220-10 or approved equal (White)  
 3 Band: 3M Opaque Film #220-13 or approved equal (Tomato Red)  
 4 Symbol: 3M Opaque Film #220-10 or approved equal (White)  
 5 Arrow: 3M Opaque Film #220-10 or approved equal (White)  
 6 Terminal I.D:  
 Terminal A 3M#230/230-127 (Intense Blue)  
 Terminal B 3M#230/230-33 (Red)  
 Terminal C 3M#230/230-26 (Green)  
 Terminal D 3M#220-98 (Dark Violet)  
 7 Detail: 3M Opaque Film # 220-45 or approved equal (Yellow)

GRAPHICS: N/A

ARROWS: N/A

MOUNTING: Post Mounted.

ILLUMINATION: Sign will be Non Illuminated.

REMARKS: Refer to Section 2.5 for vinyl specifications

NOTES:

- 1 Wall surface (varies); wood barriers, metal panels, or posts.
- 2 Aluminum panel, mounted on various wall surfaces with bolts punctured through the panel surface.
- 3 When applicable, drill only into mortar joints avoiding solid masonry faces.

Use mounting plate if necessary for variable wall conditions.

**Informational Signs - Pedestrian 3.5.1**



#	Revision	Date

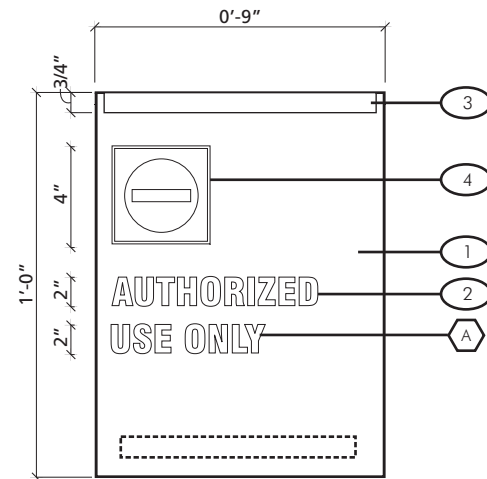

SIGN FACE LAYOUT  
Scale: 1/6" = 1'-0"

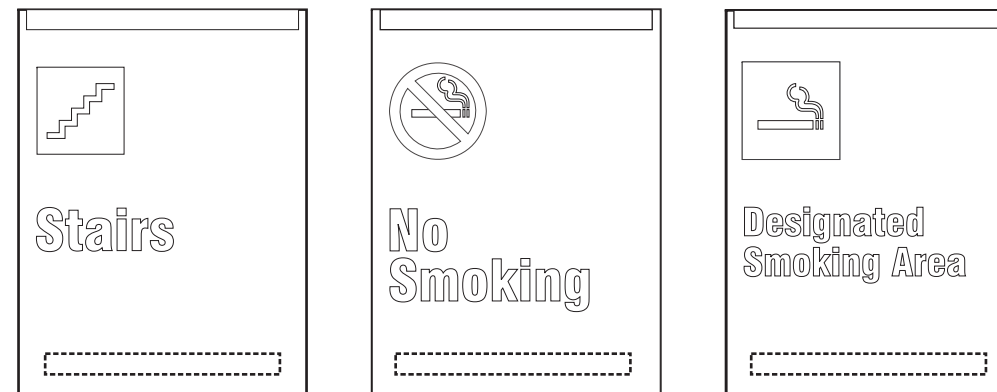

SIGN FACE ALTERNATE LAYOUTS  
Scale: 1/6" = 1'-0"



ELEVATION  
Scale: N.T.S.

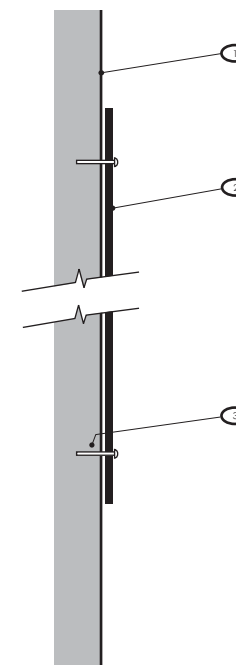

DETAIL  
Scale: N.T.S.

**Post Mount - Informational ST - 392**

DESCRIPTION: General Regulatory

LOCATION: Used in and around parking garages areas.

MATERIALS: Fabricated stainless steel panel with vinyl graphics.

LETTERING:  
A Swiss721 BlkCnBT Bold  
B N/A

SYMBOLGY: Refer to Section 2.2.2

COLORS:  
1 Background: 3M Opaque Film #7725-12 or approved equal (Black)  
2 Text: 3M Opaque Film #220-10 or approved equal (White)  
3 Band: 3M Opaque Film to match PMS #425 C or approved equal (Gray)  
4 Symbol: 3M Opaque Film #220-10 or approved equal (White)  
5 Arrow: 3M Opaque Film #220-10 or approved equal (White)  
6 Terminal I.D.:  
Terminal A 3M#230/230-127 (Intense Blue)  
Terminal B 3M#230/230-33 (Red)  
Terminal C 3M#230/230-26 (Green)  
Terminal D 3M#220-98 (Dark Violet)  
7 Arrow circle: 3M Opaque Film (dark Gray) #7725-41

GRAPHICS: N/A

ARROWS: N/A

MOUNTING: Post Mounted.

ILLUMINATION: Sign will be Non Illuminated.

REMARKS: Refer to Section 2.5 for vinyl specifications

NOTES:

- 1 Wall surface (varies); wood barriers, metal panels, or posts.
- 2 Aluminum panel, mounted on various wall surfaces with bolts punctured through the panel surface.
- 3 When applicable, drill only into mortar joints avoiding solid masonry faces.

Use mounting plate if necessary for variable wall conditions.

**Informational Signs - Pedestrian 3.5.1**



#	Revision	Date

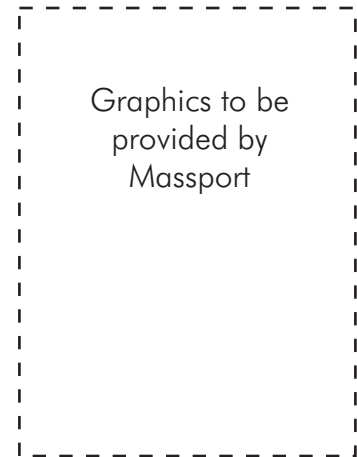

**Wall Mount - Informational ST - 393**

**DESCRIPTION:** Garage Directory

**LOCATION:** Parking garage at elevator banks.

**MATERIALS:** Photographic digital lambda process color print.

**LETTERING:**  
 Ⓐ N/A  
 Ⓑ N/A

**SYMBOLOLOGY:** Refer to Section 2.2.2

**COLORS:** N/A

**GRAPHICS:** Graphics to be provided by Massport.

**ARROWS:** N/A

**MOUNTING:** Wall Mounted.

**ILLUMINATION:** Sign will be Non Illuminated.

**REMARKS:** Refer to Section 2.5 for vinyl specifications

**SIGN FACE LAYOUT**

Scale: NTS



**ELEVATION**

Scale: N.T.S.

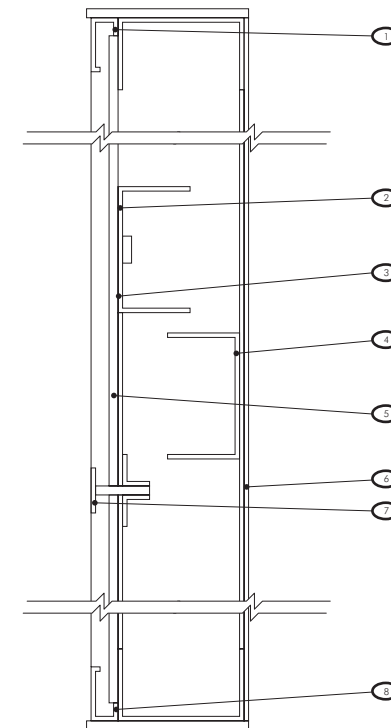

**DETAIL**

Scale: N.T.S.

**NOTES:**

- ① 1/2" X 1" aluminum tube bottom right corner cut as shown.
- ② 2-1/2" x 1-1/2" aluminum channel back stay to support sign.
- ③ Weld to channel flush at face.
- ④ 2-1/2" x 1-1/2" aluminum channel added for wall mount units; two required along back.
- ⑤ 3/16" thick sintra panel with graphics.
- ⑥ 1/16" aluminum backer panel for sign support, painted black.
- ⑦ Removable sign divider.
- ⑧ 1/2" X 1" aluminum tube top right corner cut as shown

**Informational Signs - Pedestrian 3.5.1**



#	Revision	Date



**Wall Mount - Informational ST - 394**

**DESCRIPTION:** Elevator Button Directory  
**LOCATION:** Inside elevator cabs above call buttons.  
**MATERIALS:** N/A  
**LETTERING:**  
 A N/A  
 B N/A  
**SYMBOLOLOGY:** N/A  
**COLORS:** N/A  
**GRAPHICS:** Graphics to be provided by Massport.  
**ARROWS:** N/A  
**MOUNTING:** Wall Mounted.  
**ILLUMINATION:** Sign will be Non Illuminated.  
**REMARKS:** Refer to Section 2.5 for vinyl specifications

SIGN FACE LAYOUT  
 Scale: NTS



ELEVATION  
 Scale: N.T.S.

**Informational Signs - Pedestrian 3.5.1**