

#	Revision	Date

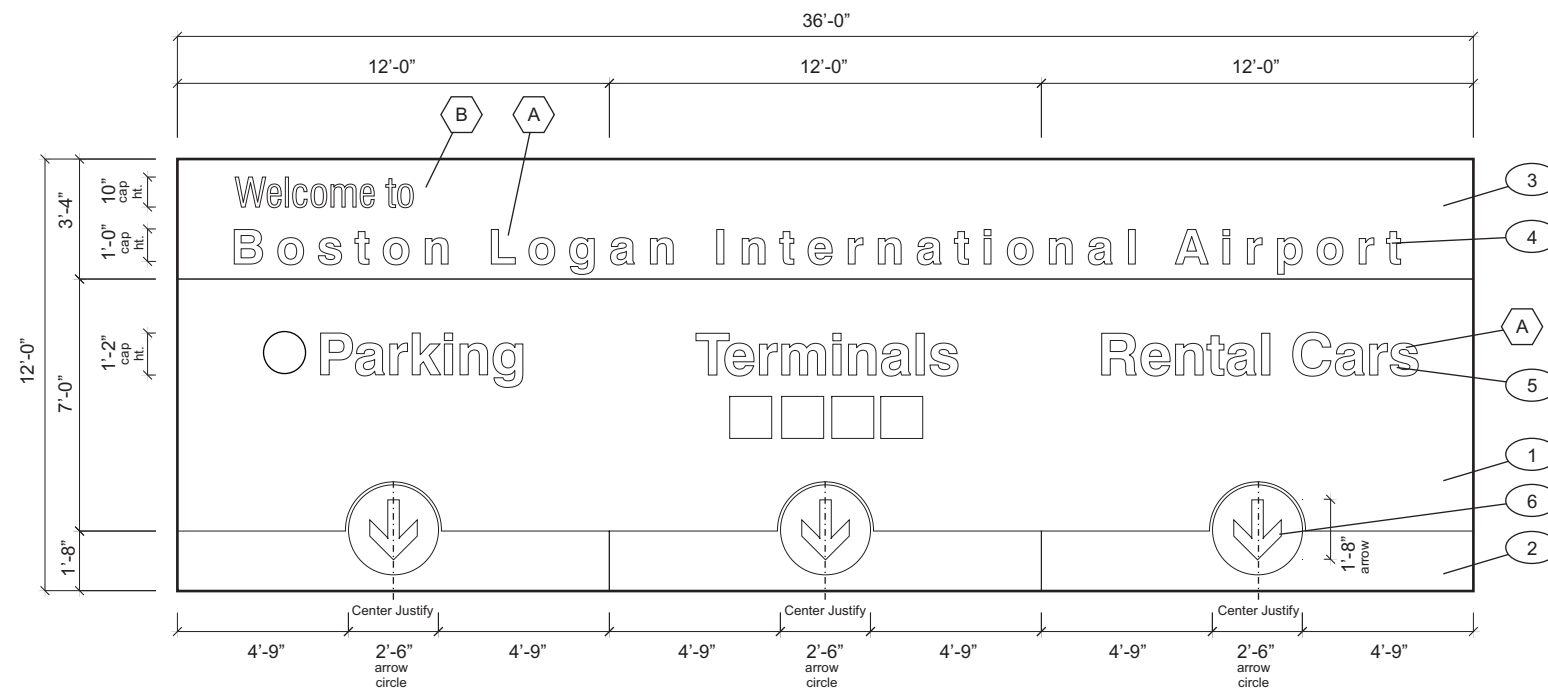

SIGN FACE LAYOUT  
Scale: 3/16" = 1'-0"

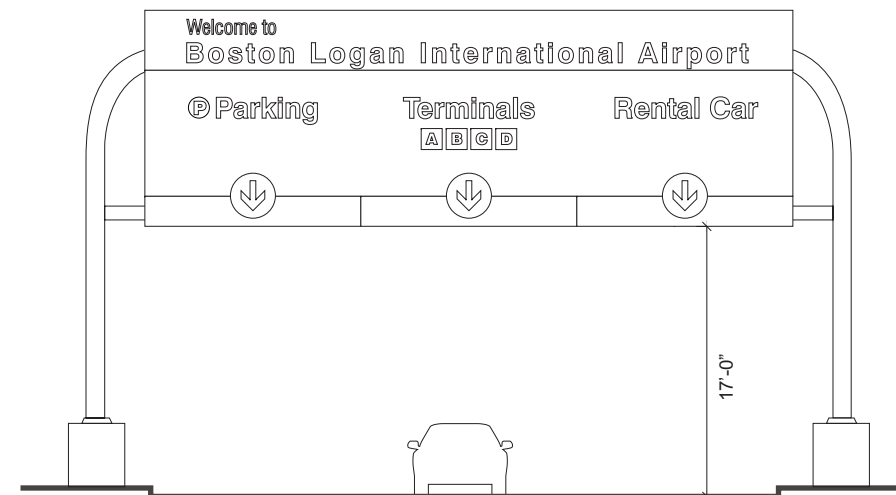

ELEVATION  
Scale: N.T.S.

Note: See page 3-38 for attachment methods.

**Directional - Overhead** **ST - 401**

- DESCRIPTION:** Overhead directional.
- LOCATION:** Roadways perpendicular to vehicular traffic.
- MATERIALS:** Aluminum sign face with reflective vinyl.
- LETTERING:**  
 A Swiss721 BT Bold  
 B Swiss721 Condensed BT Bold
- SYMBOLGY:** (Refer to Section 2.2.2)
- COLORS:**  
 1 Background: Paint Matthew's #78A-1A Jet Black  
 2 Band: 3M Opaque Film (Dark Gray) #7725-41  
 3 Header: Brushed Aluminum  
 4 Text: 3M reflective film #680-85 (black)  
 5 Text: 3M reflective film #3990 (white)  
 6 Arrow: 3M reflective film #3990 (white)
- GRAPHICS:** N/A
- ARROWS:** N/A
- MOUNTING:** Overhead directional.
- ILLUMINATION:** Sign will be Externally Illuminated.

**NOTE:** Please refer to following pages for alternate layouts.

**Directional Signs - Primary** **3.5.1**



#	Revision	Date

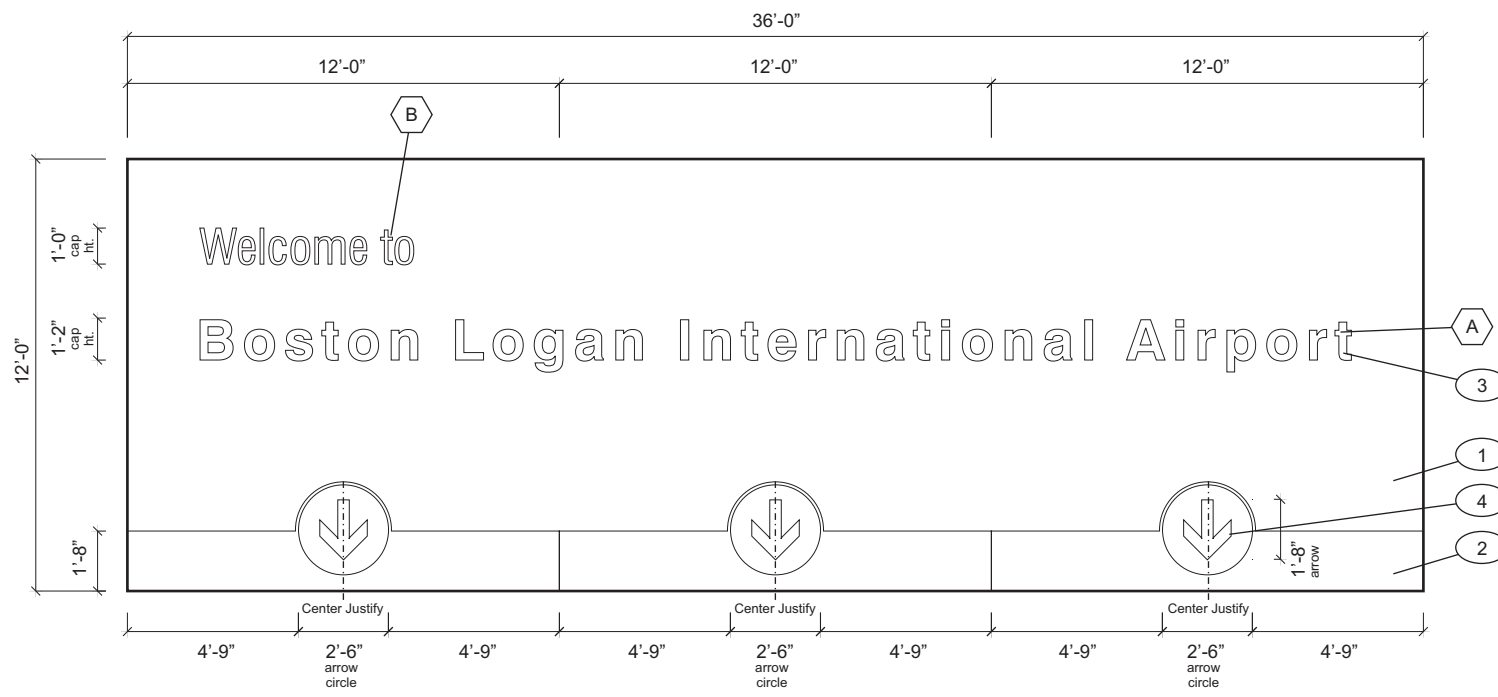

SIGN FACE LAYOUT - ALTERNATE LAYOUT

Scale: 3/16" = 1'-0"

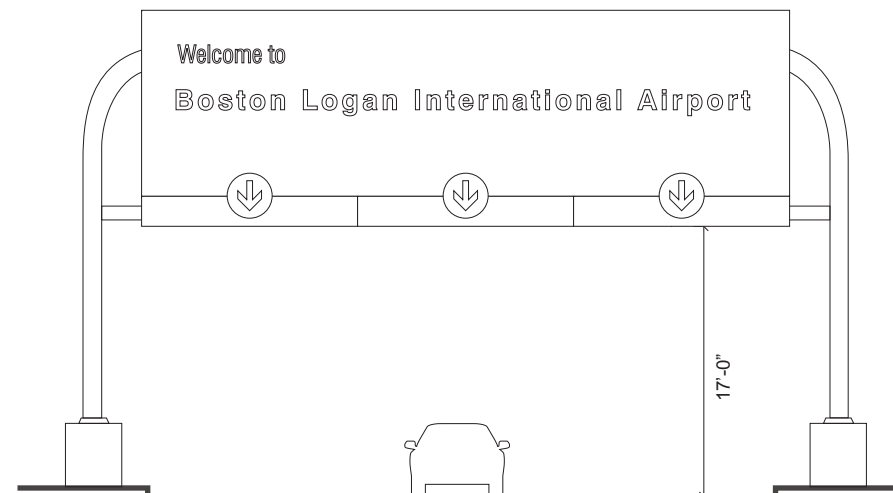

Note: See page 3-38 for attachment methods.

ELEVATION  
Scale: N.T.S.

**Directional - Overhead** **ST - 402**

**DESCRIPTION:** Overhead directional.

**LOCATION:** Roadways perpendicular to vehicular traffic.

**MATERIALS:** Aluminum sign face with reflective vinyl.

**LETTERING:**

- Ⓐ Swiss721 Condensed BT Bold
- Ⓑ Swiss721 Condensed BT Bold

**SYMBOLGY:** (Refer to Section 2.2.2)

**COLORS:**

- ① Background: Paint Matthew's #78A-1A Jet Black
- ② Band: 3M Opaque Film (Dark Gray) #7725-41
- ③ Text: 3M reflective film #3990 (white)
- ④ Arrow: 3M reflective film #3990 (white)

**GRAPHICS:** N/A

**ARROWS:** N/A

**MOUNTING:** Overhead directional.

**ILLUMINATION:** Sign will be Externally Illuminated.

**REMARKS:** For final submittal materials, colors, and text will be called out in the layouts.

**Directional Signs - Primary** **3.5.1**



#	Revision	Date

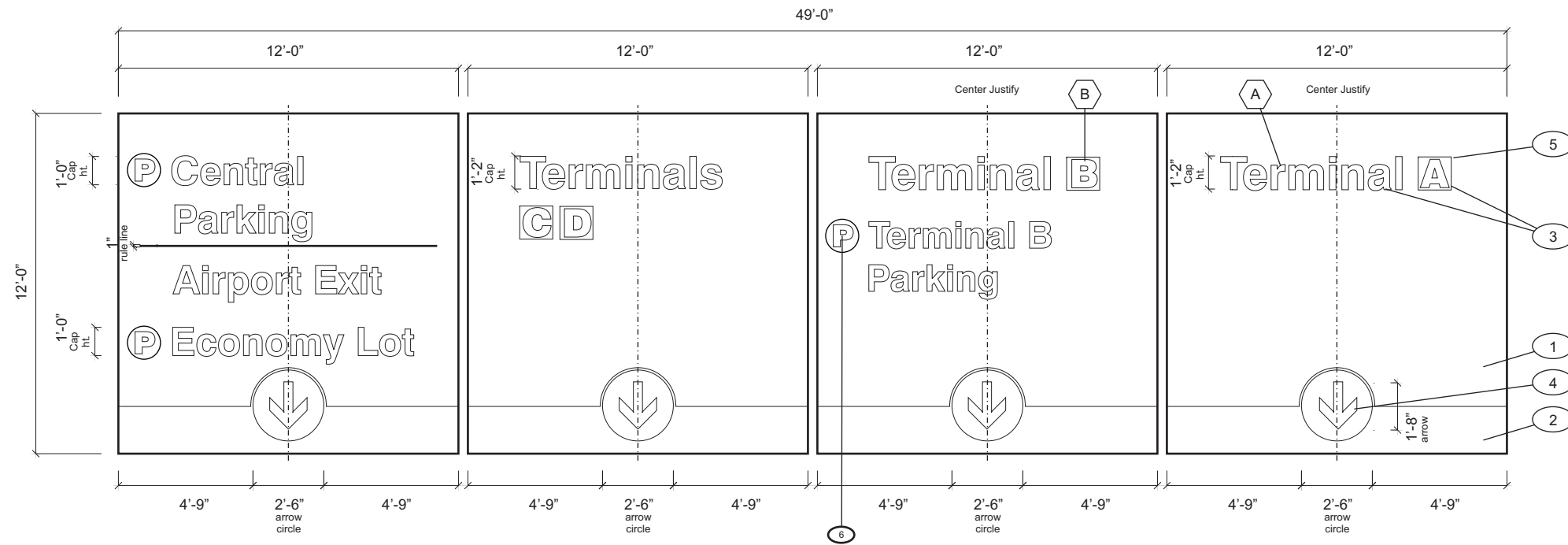

SIGN FACE LAYOUT  
Scale: 3/16" = 1'-0"

**Directional - Overhead ST - 403**

**DESCRIPTION:** Overhead directional - 4 panels  
**LOCATION:** Roadways perpendicular to vehicular traffic.

**MATERIALS:** Aluminum sign face with reflective vinyl.

**LETTERING:**  
A Swiss721 BT Bold  
B Swiss721 Blk BT

**SYMBOLGY:** (Refer to Section 2.2.2)

**COLORS:**  
1 Background: Paint Matthew's #78A-1A Jet Black  
2 Band: 3M Opaque Film (Dark Gray) #7725-41  
3 Text: 3M reflective film #3990 (white)  
4 Arrow: 3M reflective film #3990 (white)  
5 Terminal A 3M#230/230-127 (Intense Blue)  
Terminal B 3M#230/230-33 (Red)  
Terminal C 3M#230/230-26 (Green)  
Terminal D 3M#220-98 (Dark Violet)  
6 Parking P 3M Vivid Blue Film # 220-17

**GRAPHICS:** N/A

**ARROWS:** 20"

**MOUNTING:** Overhead directional.

**ILLUMINATION:** Sign will be Externally Illuminated.

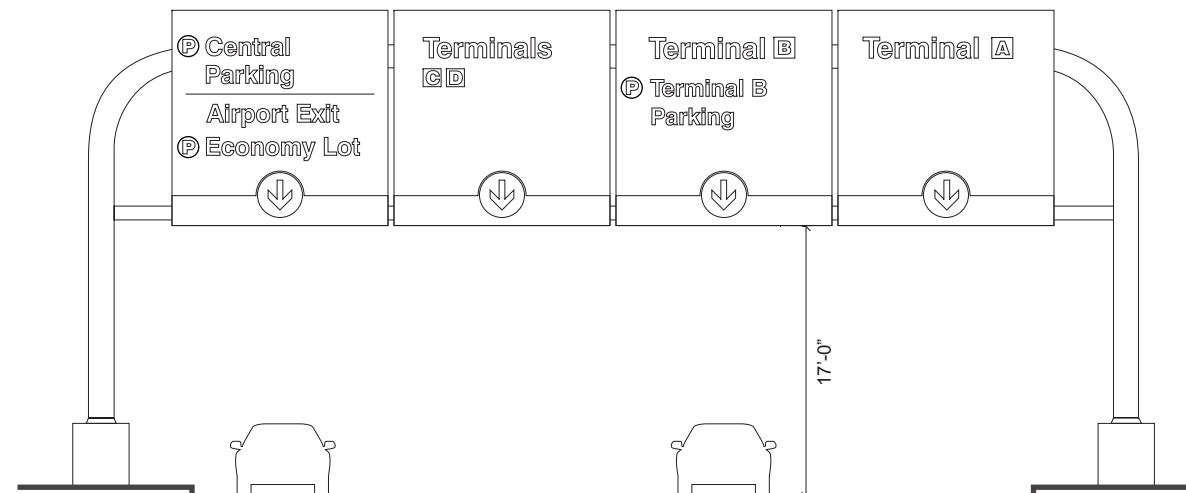

ELEVATION  
Scale: N.T.S.

Note: See page 3-38 for attachment methods.

NOTE: Please refer to following pages for alternate layouts.

**Directional Signs - Primary 3.5.1**



#	Revision	Date

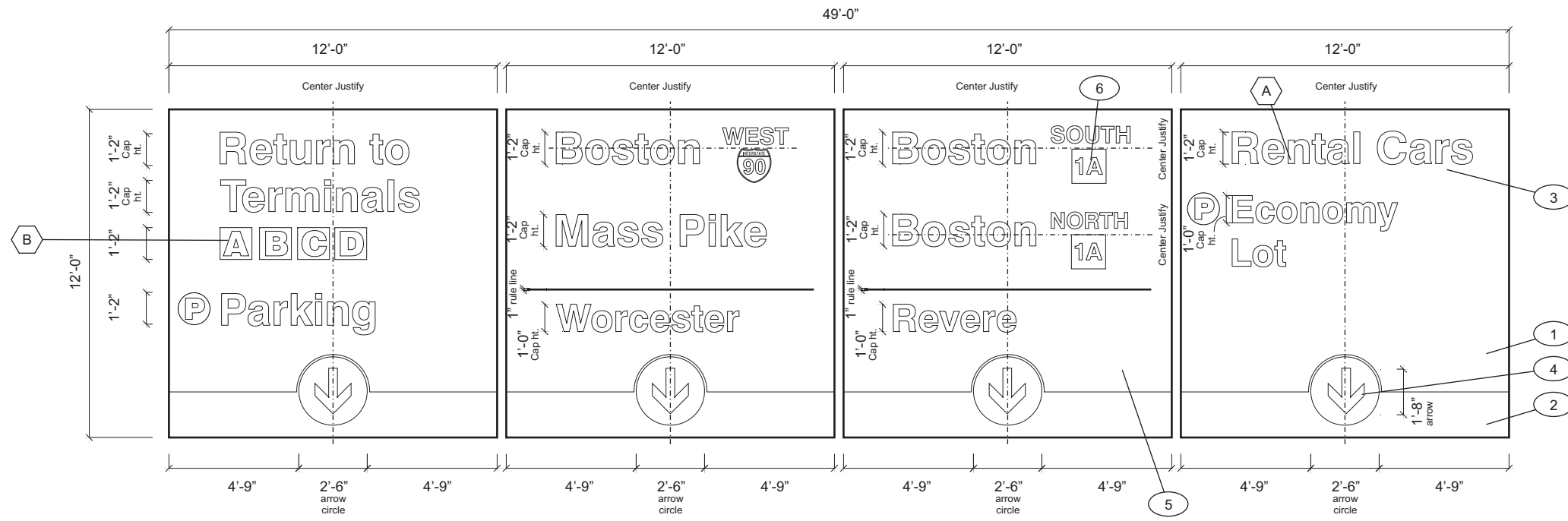

SIGN FACE ALTERNATE LAYOUT - A

Scale: 3/16" = 1'-0"

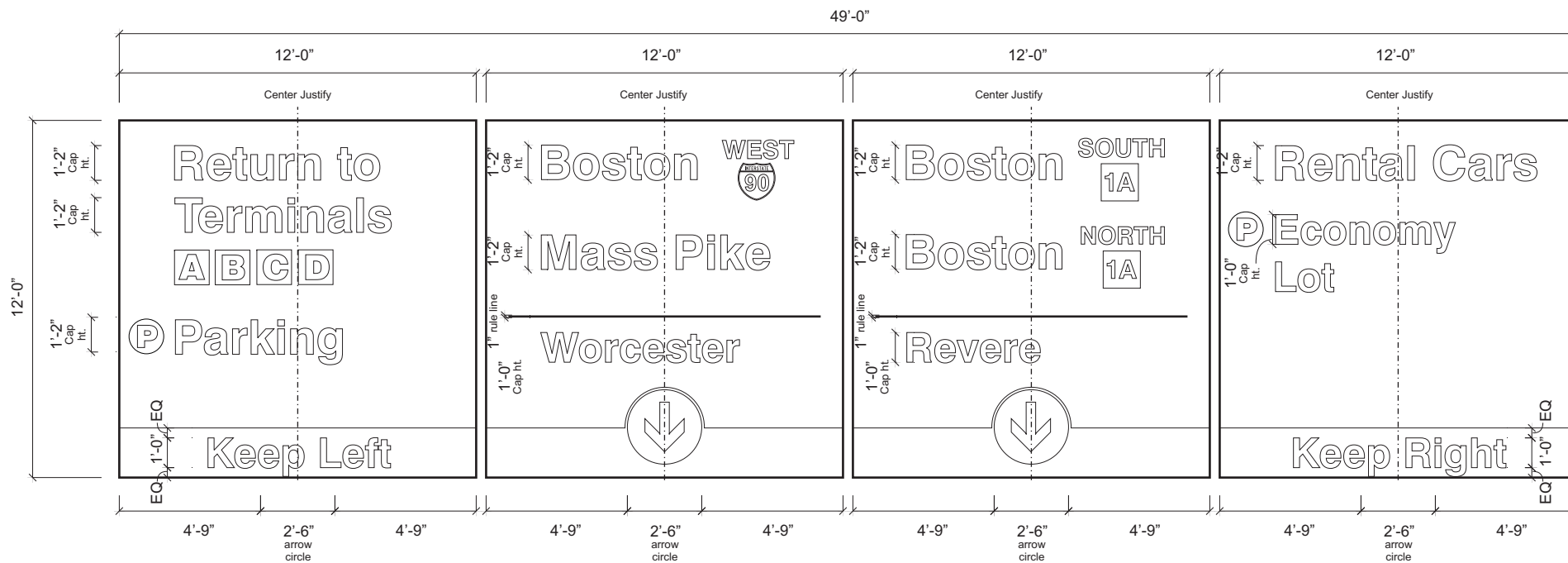

SIGN FACE ALTERNATE LAYOUT - B

Scale: 3/16" = 1'-0"

**Directional - Overhead** **ST - 403**

**DESCRIPTION:** Overhead directional - 4 panels

**LOCATION:** Roadways perpendicular to vehicular traffic.

**MATERIALS:** Aluminum sign face with reflective vinyl.

**LETTERING:**  
 A Swiss721 BT Bold  
 B Swiss721 Blk BT

**SYMBOLGY:** (Refer to Section 2.2.2)

**COLORS:**  
 1 Background: Paint Matthew's #78A-1A Jet Black  
 2 Band: 3M Opaque Film (Dark Gray) #7725-41  
 3 Text: 3M reflective film #3990 (white)  
 4 Arrow: 3M reflective film #3990 (white)  
 5 Terminal A 3M#230/230-127 (Intense Blue)  
 Terminal B 3M#230/230-33 (Red)  
 Terminal C 3M#230/230-26 (Green)  
 Terminal D 3M#220-98 (Dark Violet)  
 6 Parking P 3M Vivid Blue Film # 220-17

**GRAPHICS:** N/A

**ARROWS:** 20"

**MOUNTING:** Overhead directional.

**ILLUMINATION:** Sign will be Externally Illuminated.



#	Revision	Date

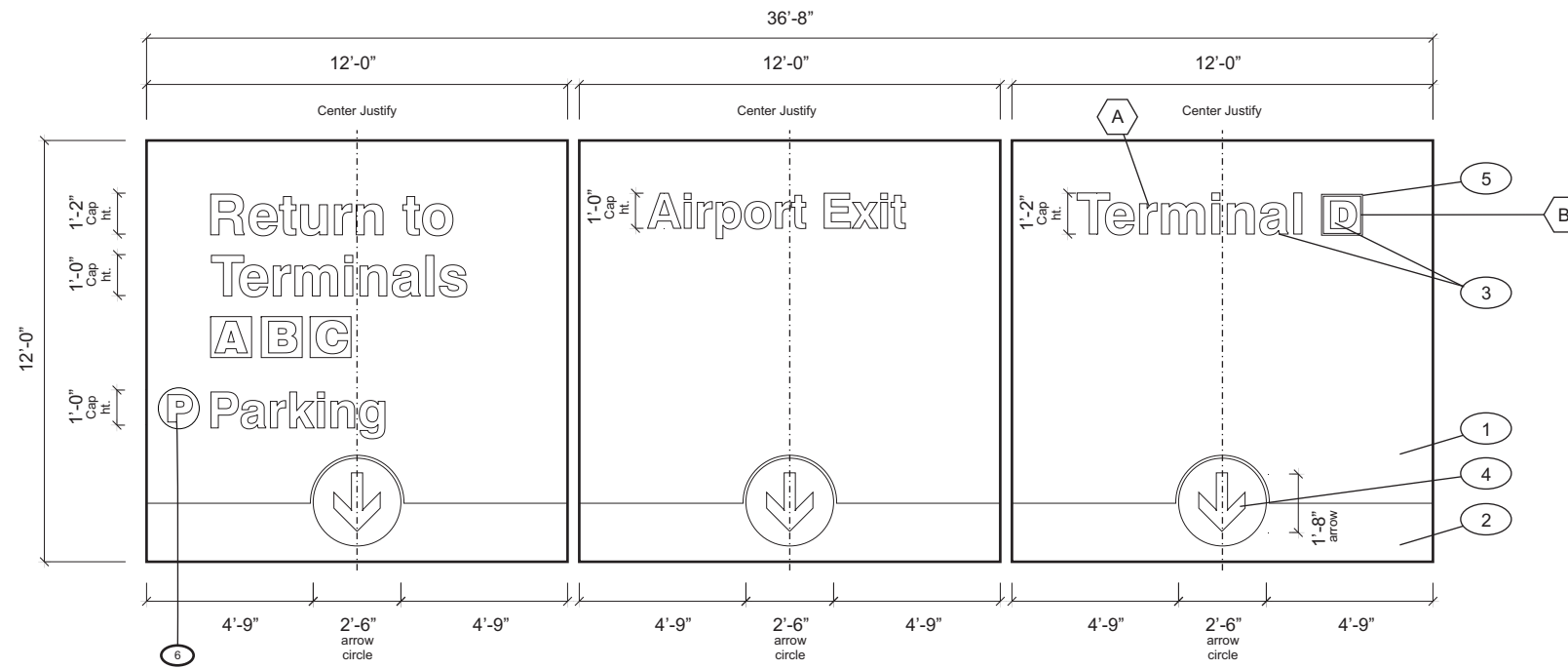

SIGN FACE LAYOUT  
Scale: 3/16" = 1'-0"

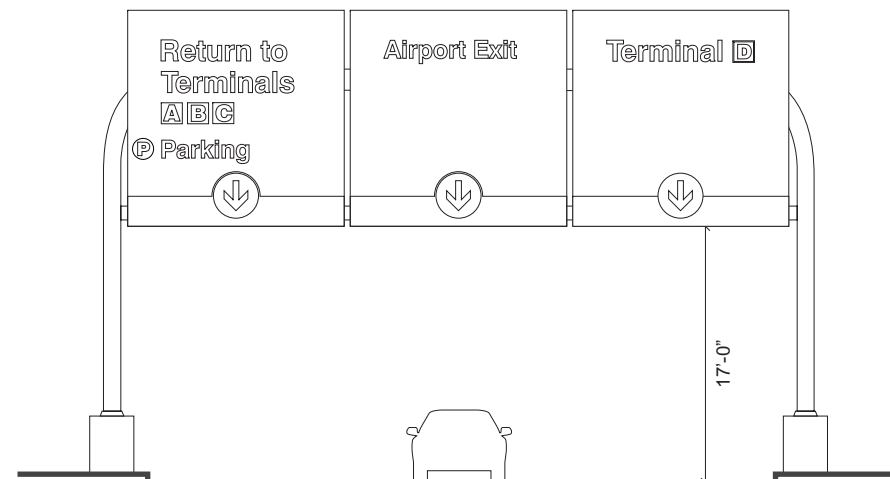

ELEVATION  
Scale: N.T.S.

Note: See page 3-38 for attachment methods.

**Directional - Overhead** **ST - 404**

**DESCRIPTION:** Overhead directional - 4 panels  
**LOCATION:** Roadways perpendicular to vehicular traffic.  
**MATERIALS:** Aluminum sign face with reflective vinyl.

**LETTERING:**  
A Swiss721 BT Bold  
B Swiss721 Blk BT

**SYMBOLGY:** (Refer to Section 2.2.2)

**COLORS:**  
1 Background: Paint Matthew's #78A-1A Jet Black  
2 Band: 3M Opaque Film (Dark Gray) #7725-41  
3 Text: 3M reflective film #3990 (white)  
4 Arrow: 3M reflective film #3990 (white)  
5 Terminal A 3M#230/230-127 (Intense Blue)  
Terminal B 3M#230/230-33 (Red)  
Terminal C 3M#230/230-26 (Green)  
Terminal D 3M#220-98 (Dark Violet)  
6 Parking P 3M Vivid Blue Film # 220-17

**GRAPHICS:** N/A  
**ARROWS:** 20"  
**MOUNTING:** Overhead directional.  
**ILLUMINATION:** Sign will be Externally Illuminated.

**NOTE:** Please refer to following pages for alternate layouts.

**Directional Signs - Primary** **3.5.1**



#	Revision	Date

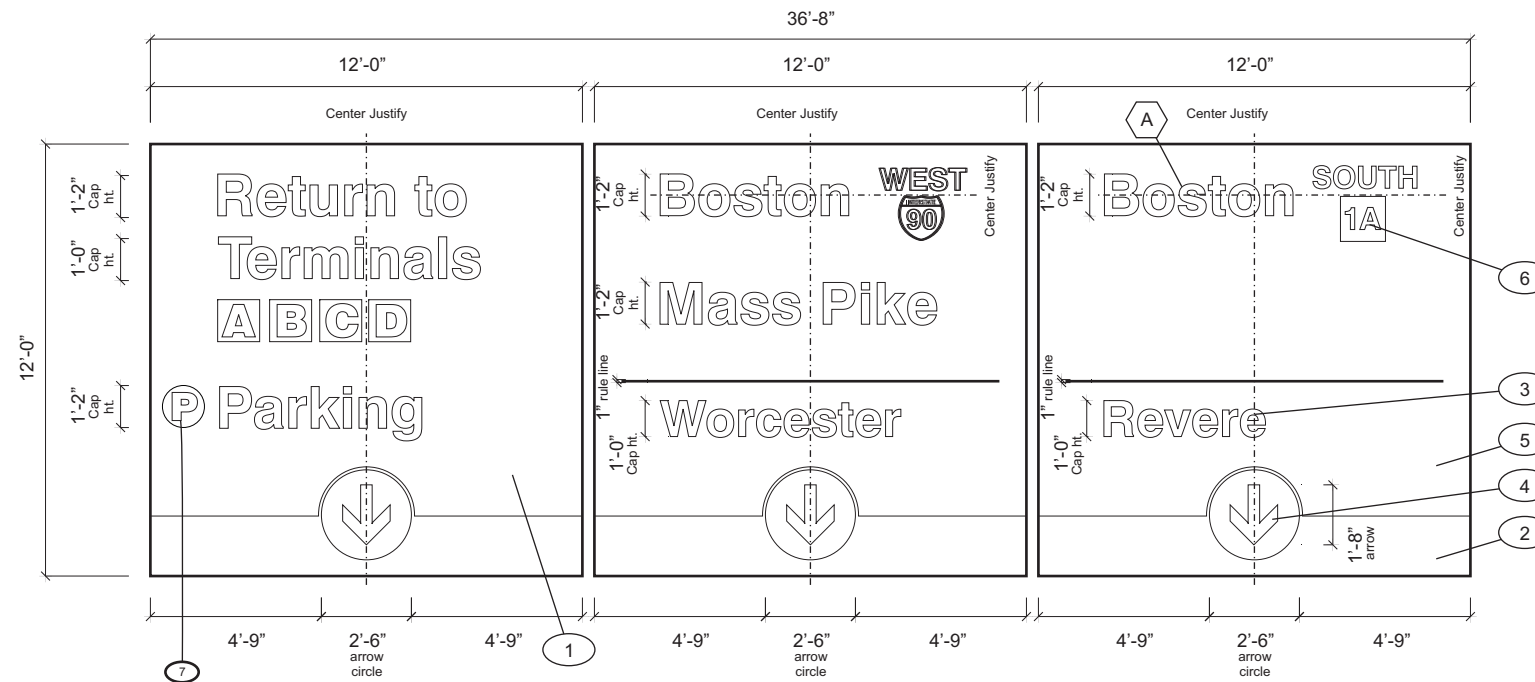

SIGN FACE ALTERNATE LAYOUT - A

Scale: 3/16" = 1'-0"

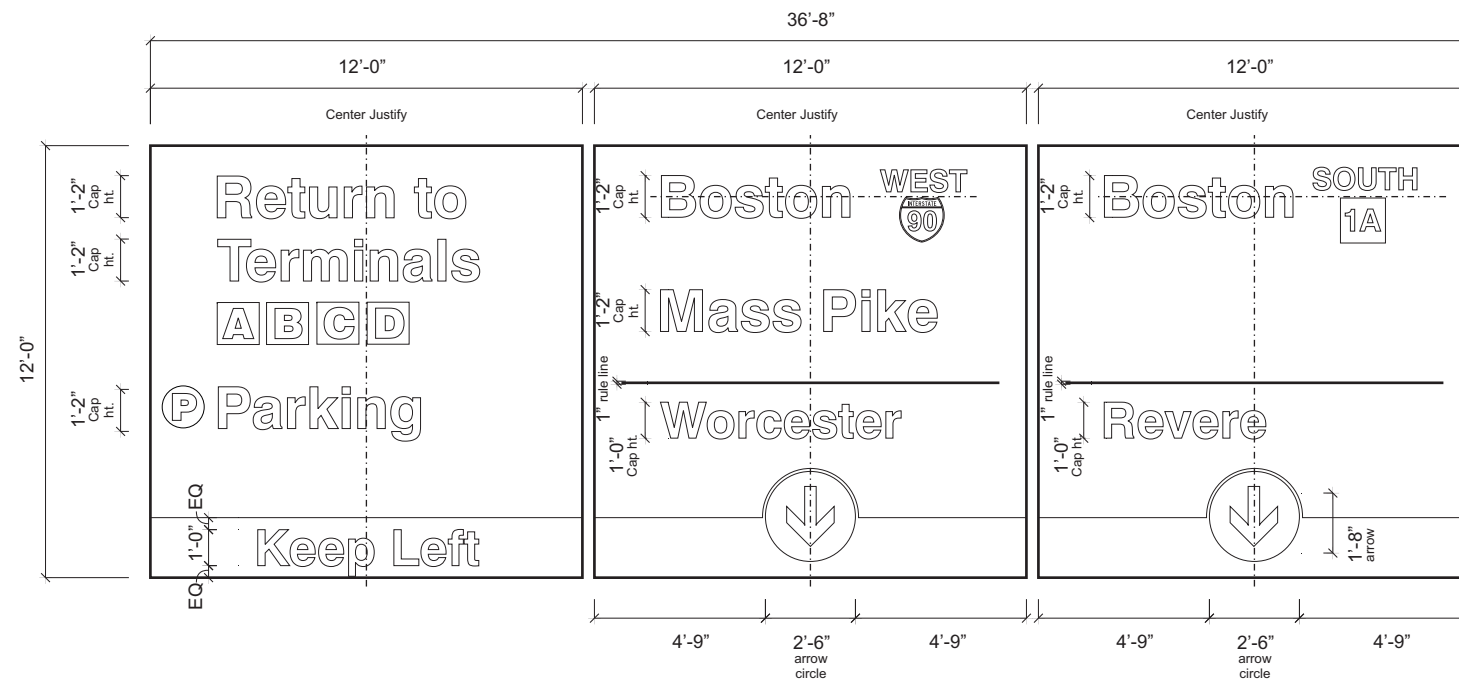

SIGN FACE ALTERNATE LAYOUT - B

Scale: 3/16" = 1'-0"

**Directional - Overhead** **ST - 404**

**DESCRIPTION:** Overhead directional - 3 panels

**LOCATION:** Roadways perpendicular to vehicular traffic.

**MATERIALS:** Aluminum sign face with reflective vinyl.

**LETTERING:**  
 A Swiss721 BT Bold  
 B N/A

**SYMBOLGY:** (Refer to Section 2.2.2)

- COLORS:**
- 1 Background: Paint Matthew's #78A-1A Jet Black
  - 2 Band: 3M Opaque Film (Dark Gray) #7725-41
  - 3 Text: 3M reflective film #3990 (white)
  - 4 Arrow: 3M reflective film #3990 (white)
  - 5 Background: Paint to match Boston DOT
  - 6 Text: 3M reflective film #680-85 (black)
  - 7 Parking P 3M Vivid Blue Film # 220-17
  - 8 Terminal A 3M#230/230-127 (Intense Blue)  
 Terminal B 3M#230/230-33 (Red)  
 Terminal C 3M#230/230-26 (Green)  
 Terminal D 3M#220-98 (Dark Violet)

**GRAPHICS:** N/A

**ARROWS:** 20"

**MOUNTING:** Overhead directional.

**ILLUMINATION:** Sign will be Externally Illuminated.



#	Revision	Date

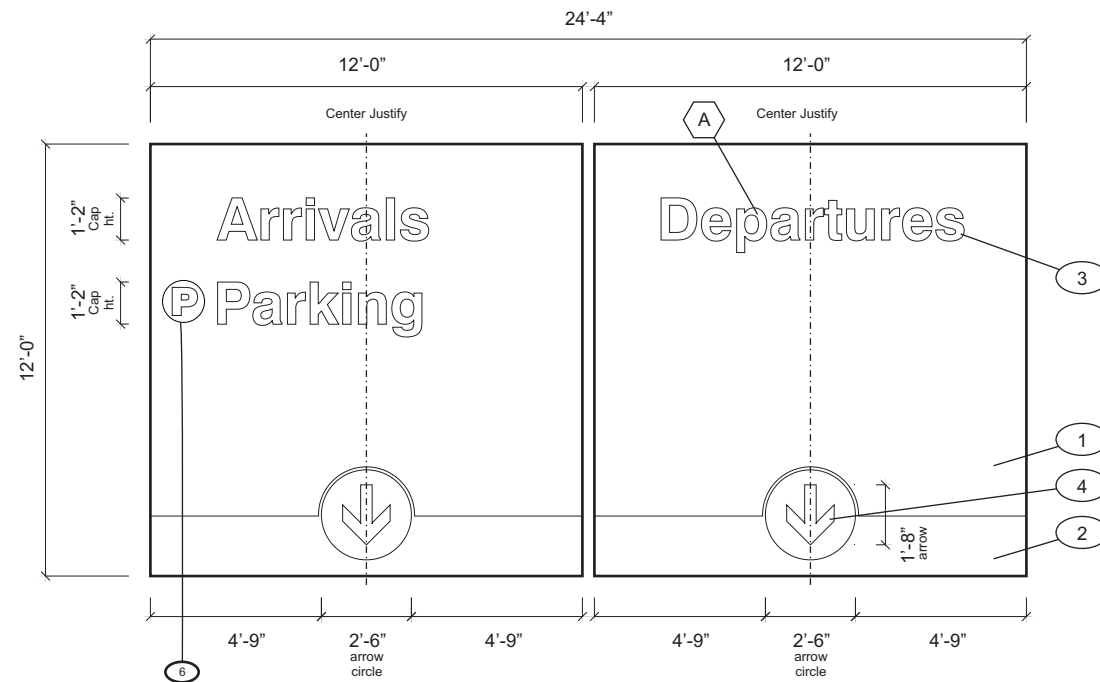

SIGN FACE LAYOUT

Scale: 3/16" = 1'-0"

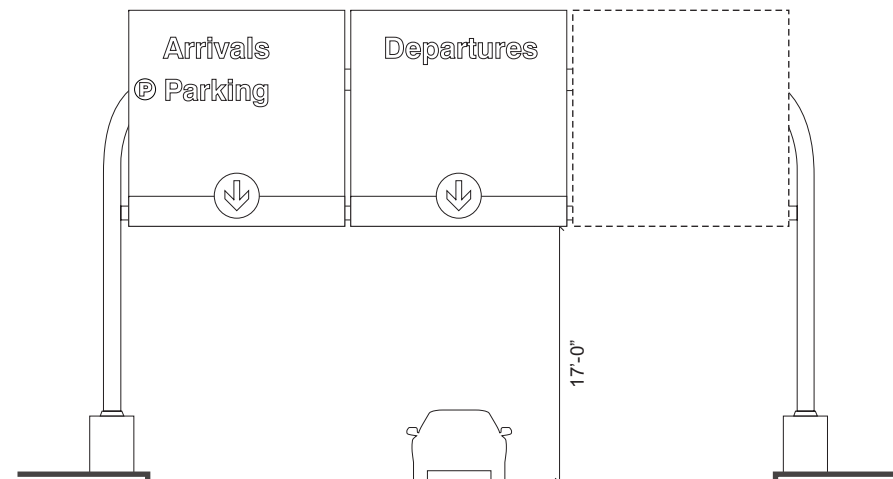

ELEVATION

Scale: N.T.S.

Note: See page 3-38 for attachment methods.

**Directional - Overhead** **ST - 405**

**DESCRIPTION:** Overhead directional - 4 panels

**LOCATION:** Roadways perpendicular to vehicular traffic.

**MATERIALS:** Aluminum sign face with reflective vinyl.

**LETTERING:**  
 A Swiss721 BT Bold  
 B Swiss721 Blk BT

**SYMBOLGY:** (Refer to Section 2.2.2)

**COLORS:**  
 1 Background: Paint Matthew's #78A-1A Jet Black  
 2 Band: 3M Opaque Film (Dark Gray) #7725-41  
 3 Text: 3M reflective film #3990 (white)  
 4 Arrow: 3M reflective film #3990 (white)  
 5 Terminal A 3M#230/230-127 (Intense Blue)  
 Terminal B 3M#230/230-33 (Red)  
 Terminal C 3M#230/230-26 (Green)  
 Terminal D 3M#220-98 (Dark Violet)  
 6 Parking P 3M Vivid Blue Film # 220-17

**GRAPHICS:** N/A

**ARROWS:** 20"

**MOUNTING:** Overhead directional.

**ILLUMINATION:** Sign will be Externally Illuminated.

**NOTE:** Please refer to following pages for alternate layouts.

**Directional Signs - Primary** **3.5.1**





#	Revision	Date

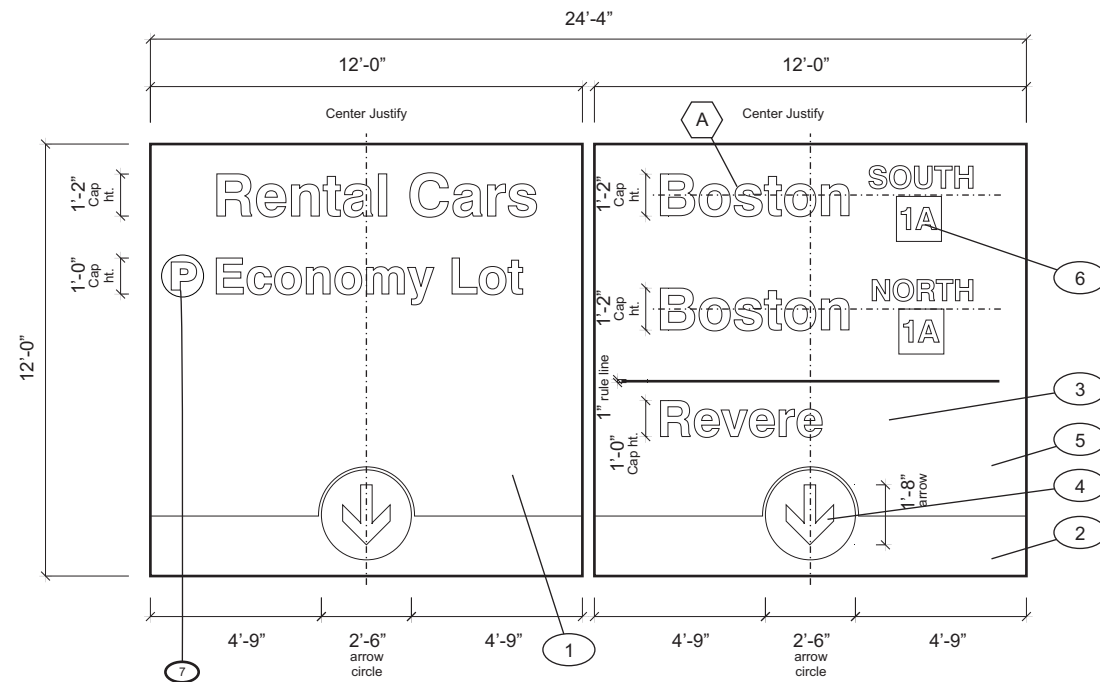

SIGN FACE ALTERNATE LAYOUT - A

Scale: 3/16" = 1'-0"

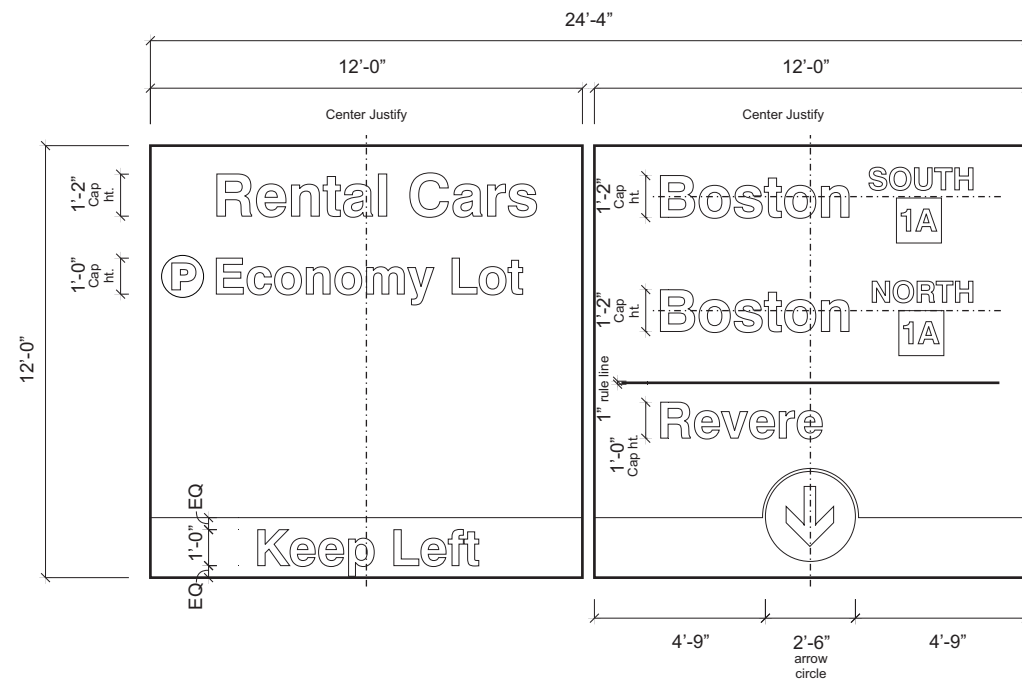

SIGN FACE ALTERNATE LAYOUT - B

Scale: 3/16" = 1'-0"

**Directional - Overhead** **ST - 405**

**DESCRIPTION:** Overhead directional - 3 panels

**LOCATION:** Roadways perpendicular to vehicular traffic.

**MATERIALS:** Aluminum sign face with reflective vinyl.

**LETTERING:**  
 A Swiss721 BT Bold  
 B N/A

**SYMBOLGY:** (Refer to Section 2.2.2)

**COLORS:**  
 1 Background: Paint Matthew's #78A-1A Jet Black  
 2 Band: 3M Opaque Film (Dark Gray) #7725-41  
 3 Text: 3M reflective film #3990 (white)  
 4 Arrow: 3M reflective film #3990 (white)  
 5 Background: Paint to match Boston DOT  
 6 Text: 3M reflective film #680-85 (black)  
 7 Parking P 3M Vivid Blue Film # 220-17  
 8 Terminal A 3M#230/230-127 (Intense Blue)  
 Terminal B 3M#230/230-33 (Red)  
 Terminal C 3M#230/230-26 (Green)  
 Terminal D 3M#220-98 (Dark Violet)

**GRAPHICS:** N/A

**ARROWS:** 20"

**MOUNTING:** Overhead directional.

**ILLUMINATION:** Sign will be Externally Illuminated.

**Directional Signs - Primary** **3.5.1**





#	Revision	Date

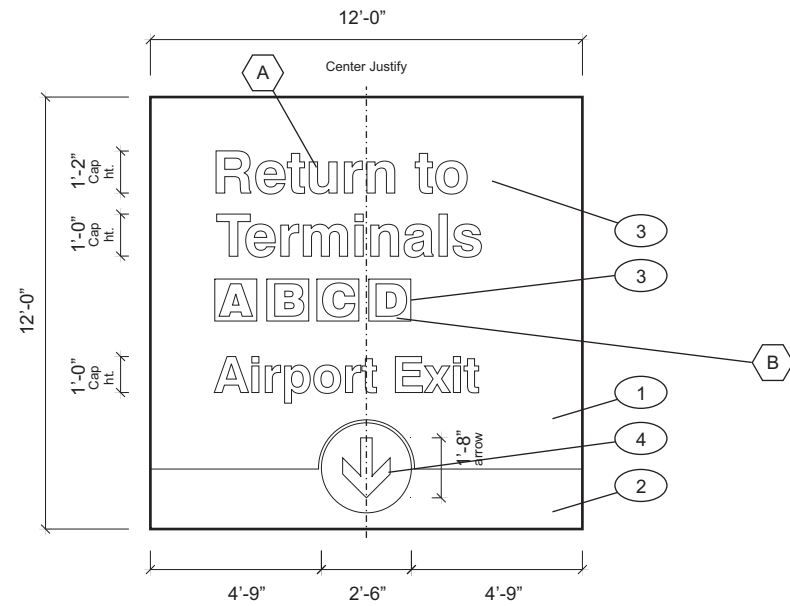

SIGN FACE LAYOUT  
Scale: 3/16" = 1'-0"

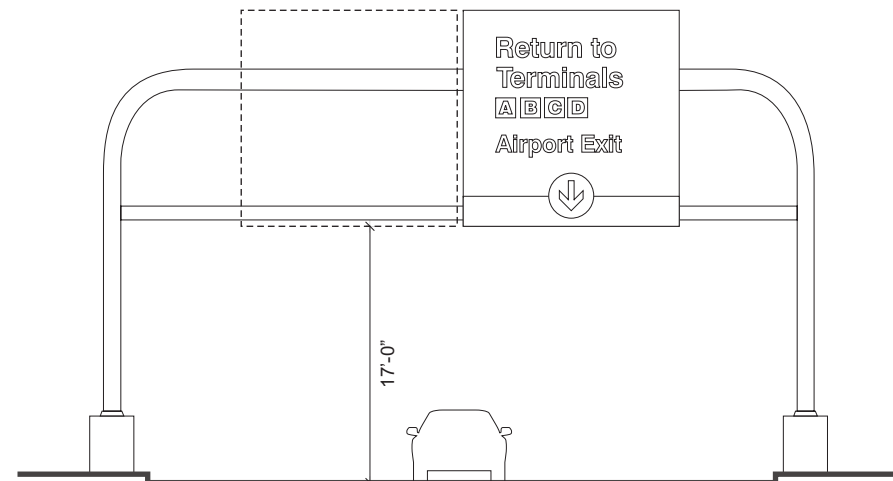

ELEVATION  
Scale: N.T.S.

Note: See page 3-38 for attachment methods.

**Directional - Overhead** **ST - 406**

**DESCRIPTION:** Overhead directional - 4 panels  
**LOCATION:** Roadways perpendicular to vehicular traffic.  
**MATERIALS:** Aluminum sign face with reflective vinyl.

**LETTERING:**  
 A Swiss721 BT Bold  
 B Swiss721 Blk BT

**SYMBOLGY:** (Refer to Section 2.2.2)

**COLORS:**  
 1 Background: Paint Matthew's #78A-1A Jet Black  
 2 Band: 3M Opaque Film (Dark Gray) #7725-41  
 3 Text: 3M reflective film #3990 (white)  
 4 Arrow: 3M reflective film #3990 (white)  
 5 Terminal A 3M#230/230-127 (Intense Blue)  
 Terminal B 3M#230/230-33 (Red)  
 Terminal C 3M#230/230-26 (Green)  
 Terminal D 3M#220-98 (Dark Violet)  
 6 Parking P 3M Vivid Blue Film # 220-17

**GRAPHICS:** N/A

**ARROWS:** 20"

**MOUNTING:** Overhead directional.

**ILLUMINATION:** Sign will be Externally Illuminated.

**REMARKS:** For final submittal materials, colors, and text will be called out in the layouts.

**NOTE:** Please refer to following pages for alternate layouts.

**Directional Signs - Primary** **3.5.1**



#	Revision	Date

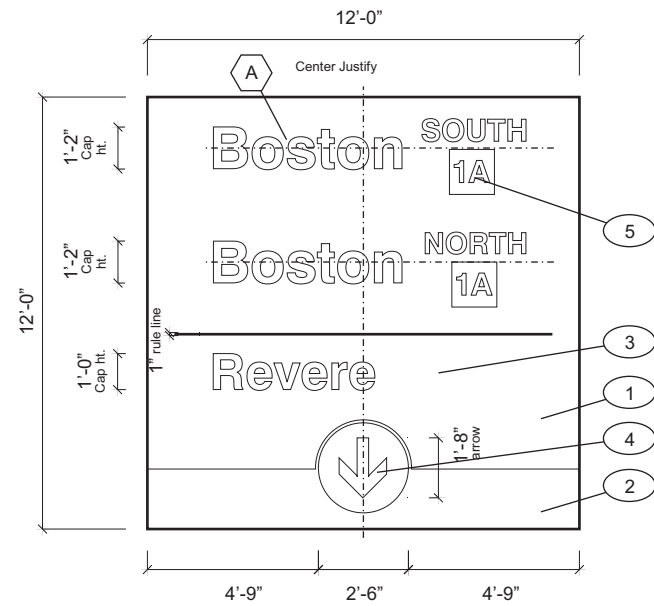

SIGN FACE ALTERNATE LAYOUT - A

Scale: 3/16" = 1'-0"

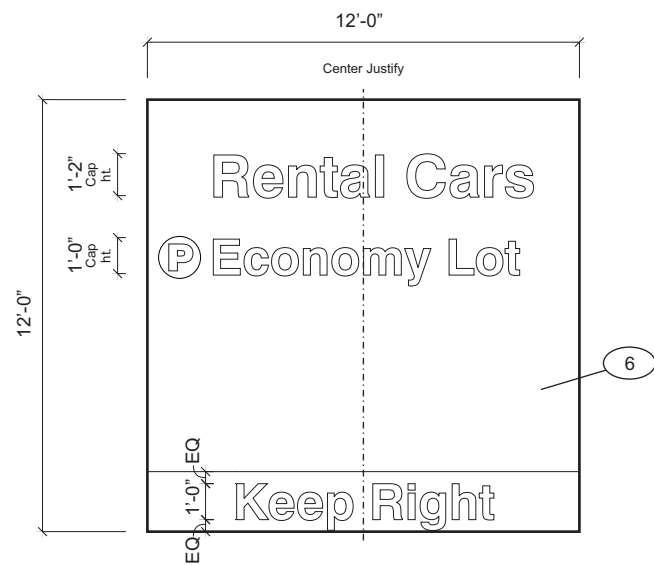

SIGN FACE ALTERNATE LAYOUT - B

Scale: 3/16" = 1'-0"

**Directional - Overhead** **ST - 406**

**DESCRIPTION:** Overhead directional - 1 panel

**LOCATION:** Roadways perpendicular to vehicular traffic.

**MATERIALS:** Aluminum sign face with reflective vinyl.

**LETTERING:**  
 A Swiss721 BT Bold  
 B Swiss721 Blk BT

**SYMBOLGY:** (Refer to Section 2.2.2)

**COLORS:**  
 1 Background: Paint to match Boston DOT  
 2 Band: P3M Opaque Film (Dark Gray) #7725-41  
 3 Text: 3M reflective film #3990 (white)  
 4 Arrow: 3M reflective film #3990 (white)  
 5 Text: 3M reflective film #680-85 (black)  
 6 Background: Paint Matthew's #78A-1A Jet Black

**GRAPHICS:** N/A

**ARROWS:** 20"

**MOUNTING:** Overhead directional.

**ILLUMINATION:** Sign will be Externally Illuminated.

**Directional Signs - Primary** **3.5.1**



#	Revision	Date

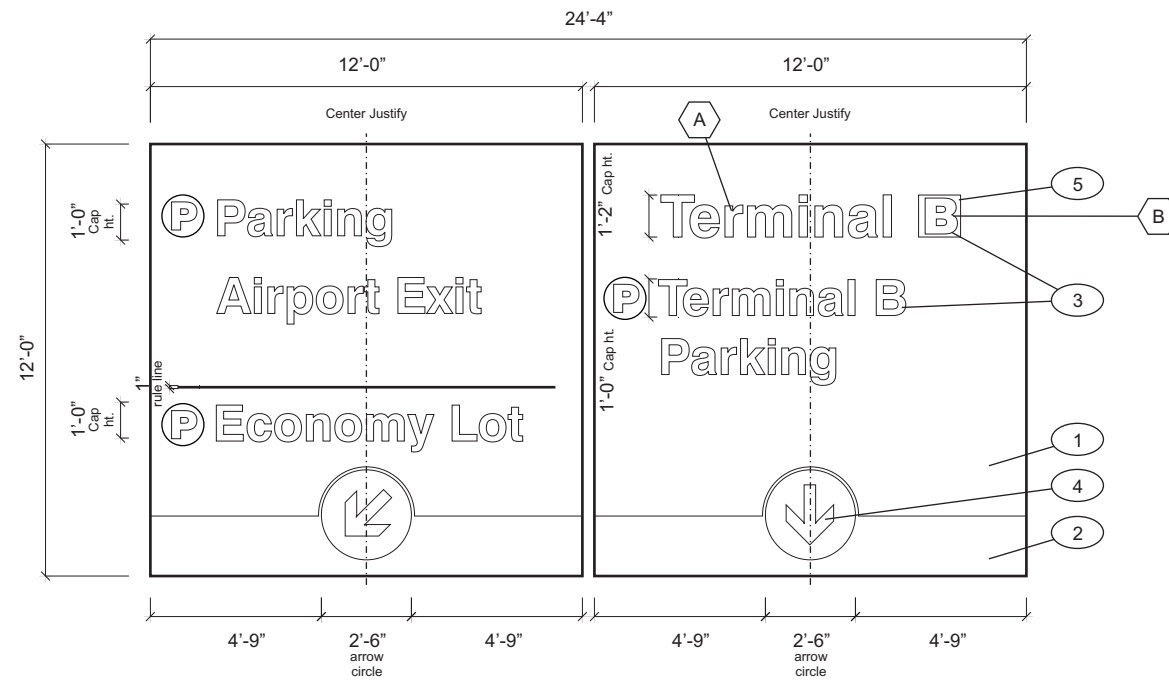

SIGN FACE LAYOUT  
Scale: 3/16" = 1'-0"

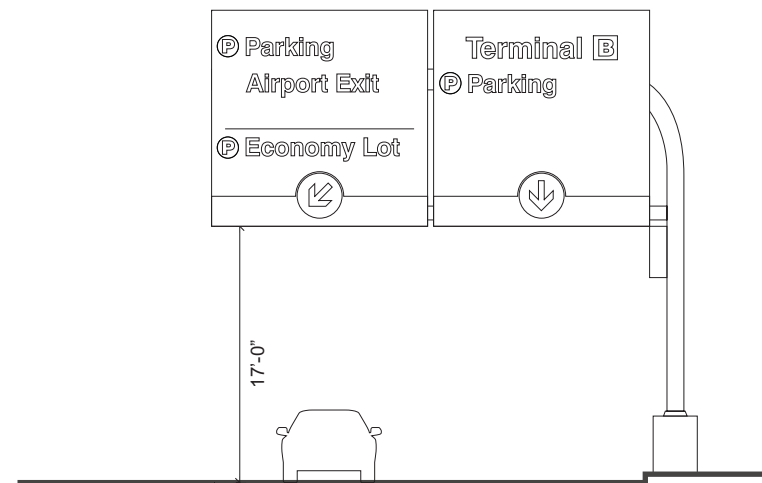

ELEVATION  
Scale: N.T.S.

Note: See page 3-38 for attachment methods.

**Directional - Overhead** **ST - 407**

**DESCRIPTION:** Overhead directional - 4 panels  
**LOCATION:** Roadways perpendicular to vehicular traffic.  
**MATERIALS:** Aluminum sign face with reflective vinyl.  
**LETTERING:**  
 A Swiss721 BT Bold  
 B Swiss721 Blk BT  
**SYMBOLGY:** (Refer to Section 2.2.2)

- COLORS:**
- 1 Background: Paint Matthew's #78A-1A Jet Black
  - 2 Band: 3M Opaque Film (Dark Gray) #7725-41
  - 3 Text: 3M reflective film #3990 (white)
  - 4 Arrow: 3M reflective film #3990 (white)
  - 5 Terminal A 3M#230/230-127 (Intense Blue)  
Terminal B 3M#230/230-33 (Red)  
Terminal C 3M#230/230-26 (Green)  
Terminal D 3M#220-98 (Dark Violet)
  - 6 Parking P 3M Vivid Blue Film # 220-17

**GRAPHICS:** N/A  
**ARROWS:** 20"  
**MOUNTING:** Overhead directional.  
**ILLUMINATION:** Sign will be Externally Illuminated.

**NOTE: Please refer to following pages for alternate layouts.**

**Directional Signs - Primary** **3.5.1**



#	Revision	Date

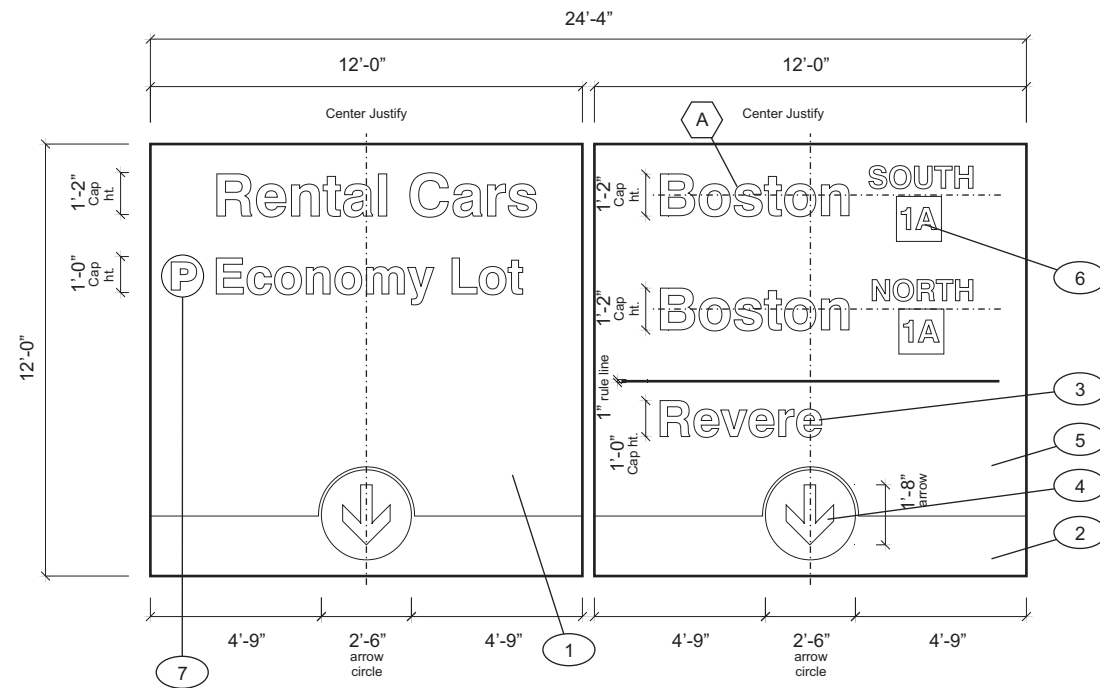

SIGN FACE ALTERNATE LAYOUT - A

Scale: 3/16" = 1'-0"

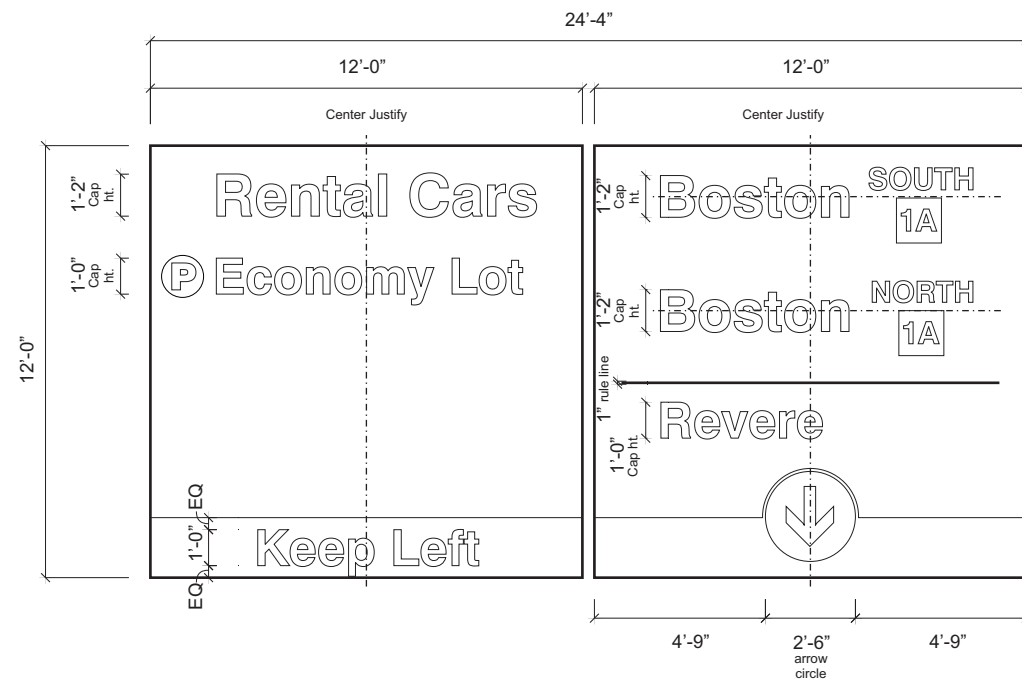

SIGN FACE ALTERNATE LAYOUT - B

Scale: 3/16" = 1'-0"

**Directional - Overhead** **ST - 407**

**DESCRIPTION:** Overhead directional - 2 panels

**LOCATION:** Roadways perpendicular to vehicular traffic.

**MATERIALS:** Aluminum sign face with reflective vinyl.

**LETTERING:**  
 A Swiss721 BT Bold  
 B N/A

**SYMBOLGY:** (Refer to Section 2.2.2)

**COLORS:**  
 1 Background: Paint Matthew's #78A-1A Jet Black  
 2 Band: 3M Opaque Film (Dark Gray) #7725-41  
 3 Text: 3M reflective film #3990 (white)  
 4 Arrow: 3M reflective film #3990 (white)  
 5 Background: Paint to match Boston DOT  
 6 Text: 3M reflective film #680-85 (black)  
 7 Parking P 3M Vivid Blue Film # 220-17

**GRAPHICS:** N/A

**ARROWS:** 20"

**MOUNTING:** Cantilever.

**ILLUMINATION:** Sign will be Externally Illuminated.



#	Revision	Date

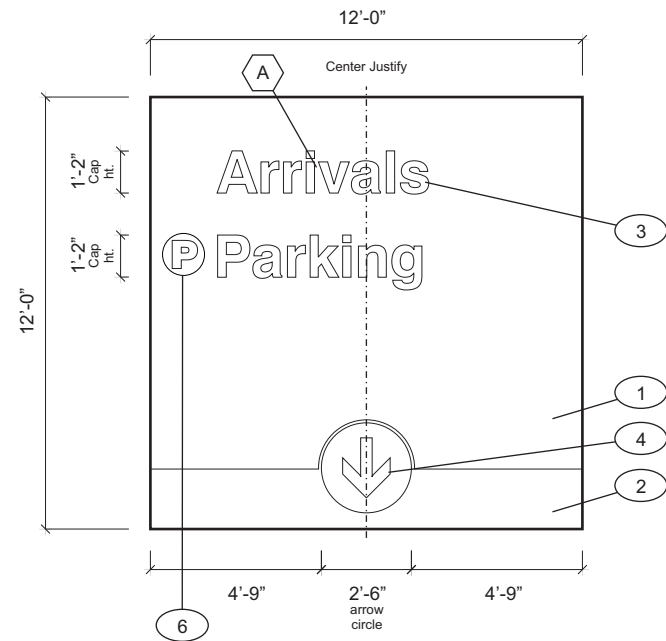

SIGN FACE LAYOUT  
Scale: 3/16" = 1'-0"

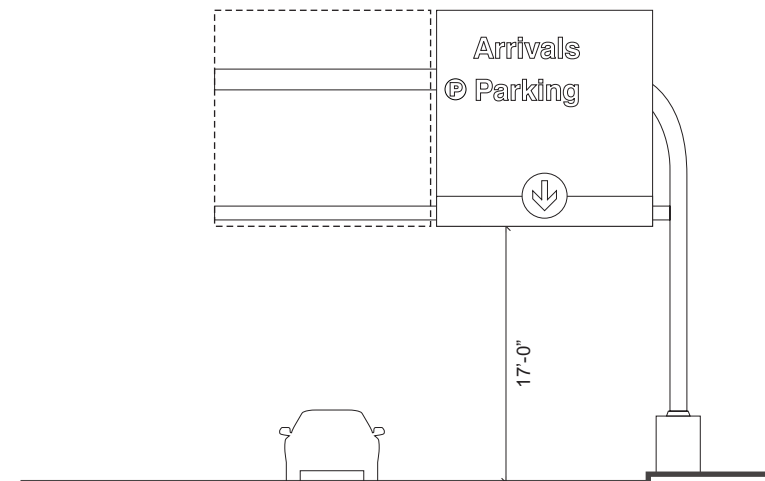

ELEVATION  
Scale: N.T.S.

**Directional - Overhead** **ST - 408**

**DESCRIPTION:** Overhead directional - 4 panels  
**LOCATION:** Roadways perpendicular to vehicular traffic.  
**MATERIALS:** Aluminum sign face with reflective vinyl.  
**LETTERING:**  
 A Swiss721 BT Bold  
 B Swiss721 Blk BT  
**SYMBOLGY:** (Refer to Section 2.2.2)

- COLORS:**
- 1 Background: Paint Matthew's #78A-1A Jet Black
  - 2 Band: 3M Opaque Film (Dark Gray) #7725-41
  - 3 Text: 3M reflective film #3990 (white)
  - 4 Arrow: 3M reflective film #3990 (white)
  - 5 Terminal A 3M#230/230-127 (Intense Blue)  
Terminal B 3M#230/230-33 (Red)  
Terminal C 3M#230/230-26 (Green)  
Terminal D 3M#220-98 (Dark Violet)
  - 6 Parking P 3M Vivid Blue Film # 220-17

**GRAPHICS:** N/A  
**ARROWS:** 20"  
**MOUNTING:** Overhead directional.  
**ILLUMINATION:** Sign will be Externally Illuminated.

Note: See page 3-38 for attachment methods.

**NOTE:** Please refer to following pages for alternate layouts.

**Directional Signs - Primary** **3.5.1**



#	Revision	Date

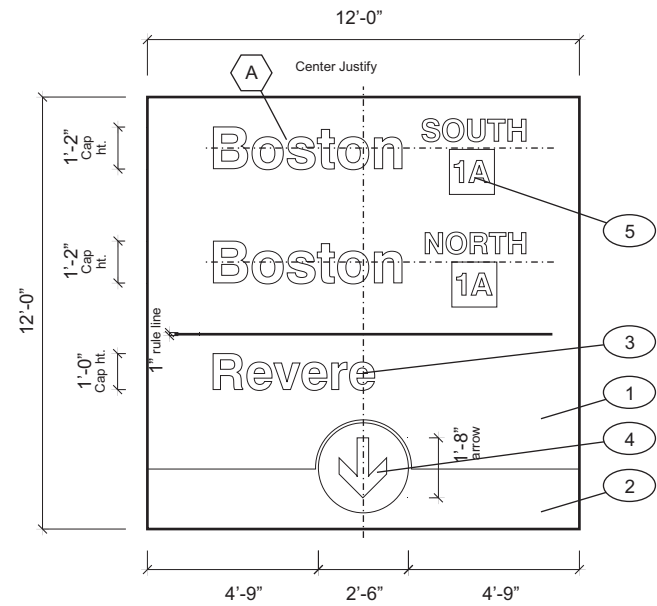

SIGN FACE ALTERNATE LAYOUT - A

Scale: 3/16" = 1'-0"

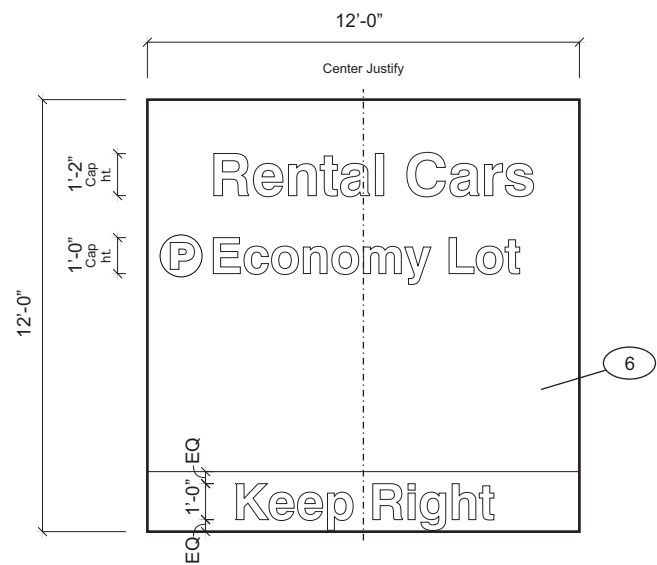

SIGN FACE ALTERNATE LAYOUT - B

Scale: 3/16" = 1'-0"

**Directional - Overhead** **ST - 408**

**DESCRIPTION:** Overhead directional - 1 panel

**LOCATION:** Roadways perpendicular to vehicular traffic.

**MATERIALS:** Aluminum sign face with reflective vinyl.

**LETTERING:**  
 A Swiss721 BT Bold  
 B Swiss721 Blk BT

**SYMBOLGY:** (Refer to Section 2.2.2)

**COLORS:**  
 1 Background: Paint to match Boston DOT  
 2 Band: 3M Opaque Film (Dark Gray) #7725-41  
 3 Text: 3M reflective film #3990 (white)  
 4 Arrow: 3M reflective film #3990 (white)  
 5 Text: 3M reflective film #680-85 (black)  
 6 Background: Paint Matthew's #78A-1A Jet Black

**GRAPHICS:** N/A

**ARROWS:** 20"

**MOUNTING:** Cantilever.

**ILLUMINATION:** Sign will be Externally Illuminated.

**Directional Signs - Primary** **3.5.1**



#	Revision	Date

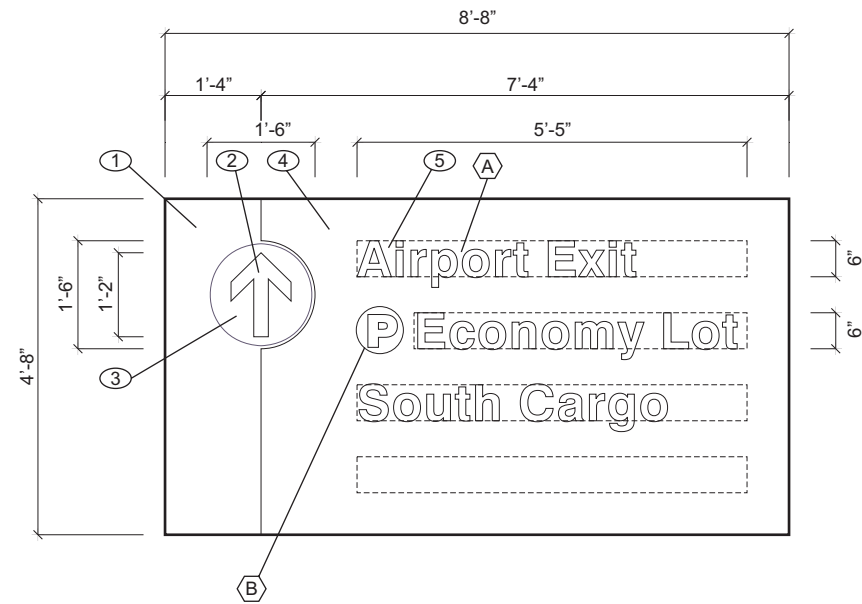

SIGN FACE LAYOUT  
Scale: 3/8" = 1'-0"

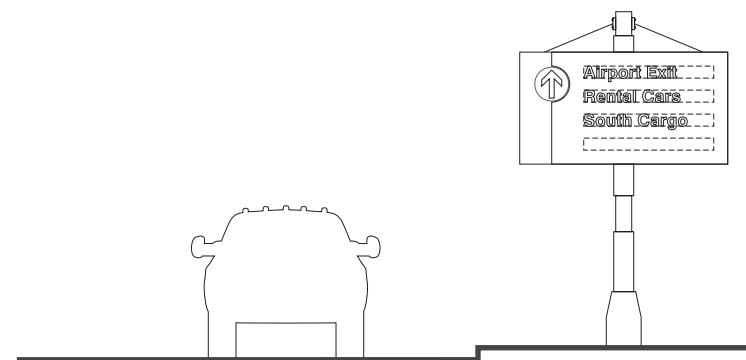

ELEVATION  
Scale: 1/8" = 1'-0"

Note: See page 3-39 for attachment methods.

**Directional - Roadside** **ST - 410**

**DESCRIPTION:** Roadside Directional - 1 panel  
**LOCATION:** Roadside perpendicular to vehicular traffic.

**MATERIALS:** Aluminum sign face with reflective vinyl.

**LETTERING:**  
 A Swiss721 BT Bold  
 B Swiss721 Blk BT

**SYMBOLGY:** (Refer to Section 2.2.2)

**COLORS:**  
 1 Band: Paint color to match dark grey #425C  
 2 Arrow: Diamond grade film #3990 white  
 3 Arrow Circle: Paint black MAP #78A-1A jet black  
 4 Background: Paint black MAP #78A-1A jet black  
 5 Text: Diamond grade film #3990 white

**GRAPHICS:** N/A

**ARROWS:** 10"

**MOUNTING:** Post mounted.

**ILLUMINATION:** Sign will be Non Illuminated.

**Directional Signs - Secondary** **3.5.1**





#	Revision	Date

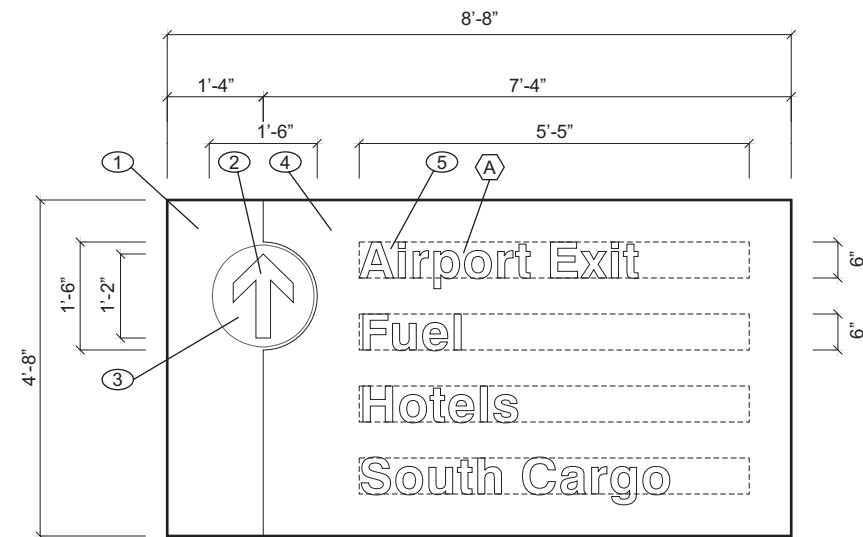

SIGN FACE LAYOUT  
Scale: 3/16" = 1'-0"

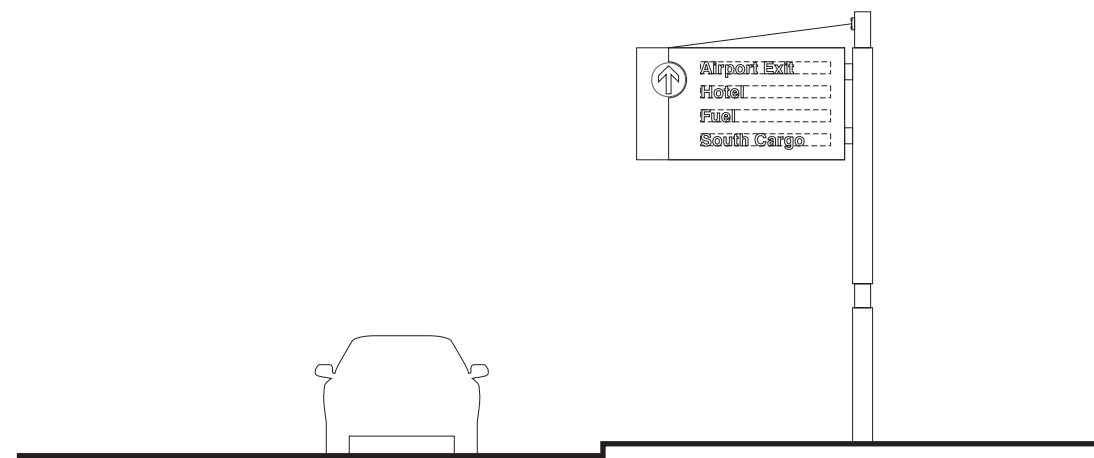

ELEVATION  
Scale: 1/8" = 1'-0"

Note: See page 3-39 for attachment methods.

**Directional - Roadside** **ST - 411**

**DESCRIPTION:** Roadside Directional - 1 panel  
**LOCATION:** Roadside perpendicular to vehicular traffic.

**MATERIALS:** Aluminum sign face with reflective vinyl.

**LETTERING:**  
 A Swiss721 BT Bold  
 B N/A

**SYMBOLGY:** (Refer to Section 2.2.2)

**COLORS:**  
 1 Band: Paint color to match dark grey #425C  
 2 Arrow: Diamond grade film #3990 white  
 3 Arrow Circle: Paint black MAP #78A-1A jet black  
 4 Background: Paint black MAP #78A-1A jet black  
 5 Text: Diamond grade film #3990 white

**GRAPHICS:** N/A

**ARROWS:** 10"

**MOUNTING:** Post mounted.

**ILLUMINATION:** Sign will be Non Illuminated.

**Directional Signs - Secondary** **3.5.1**



#	Revision	Date

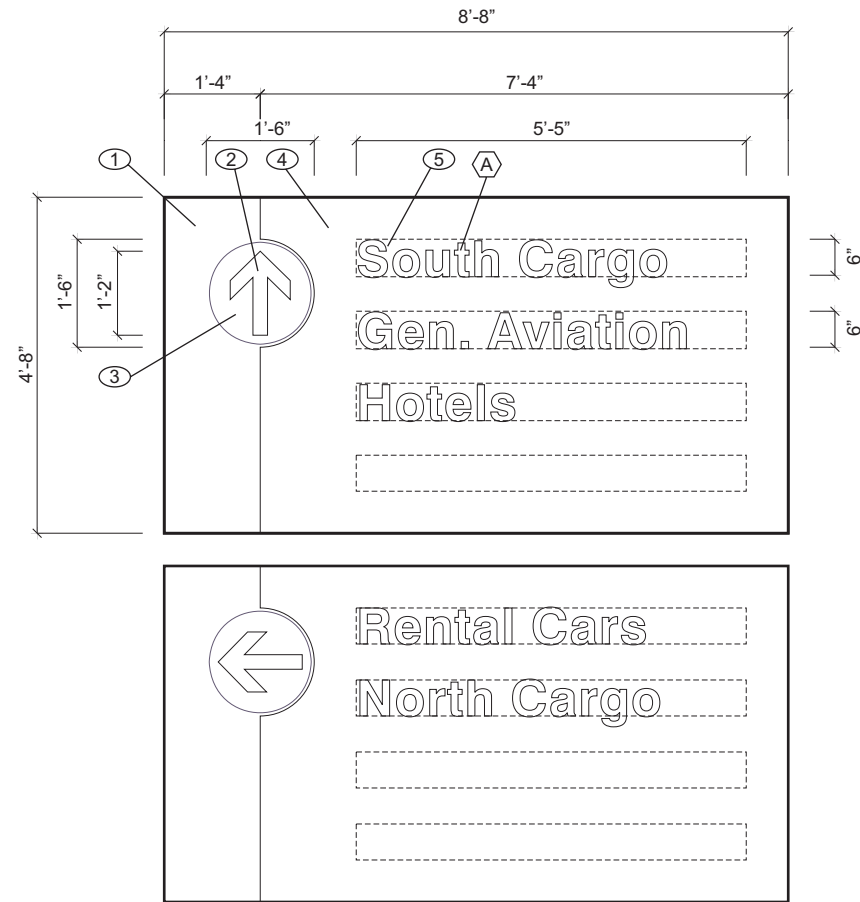

SIGN FACE LAYOUT  
Scale: 3/16" = 1'-0"

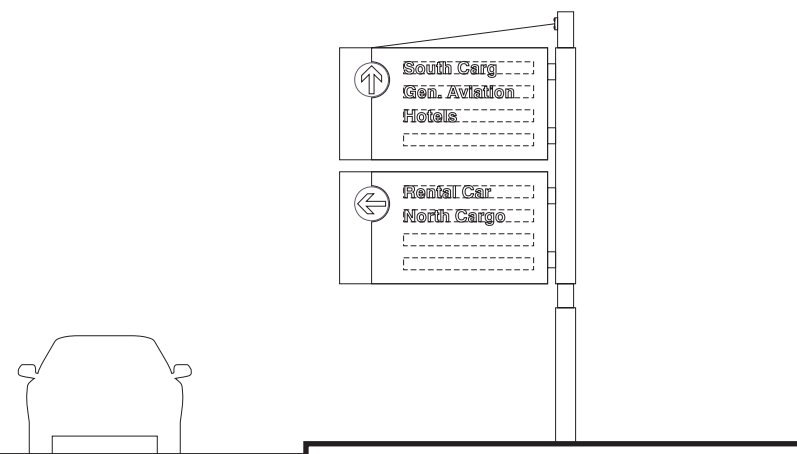

ELEVATION  
Scale: 1/8" = 1'-0"

Note: See page 3-39 for attachment methods.

**Directional - Roadside** **ST - 412**

**DESCRIPTION:** Roadside Directional - 2 panels  
**LOCATION:** Roadside perpendicular to vehicular traffic.

**MATERIALS:** Aluminum sign face with reflective vinyl.

**LETTERING:**  
 A Swiss721 BT Bold  
 B N/A

**SYMBOLGY:** (Refer to Section 2.2.2)

**COLORS:**  
 1 Band: Paint color to match dark grey #425C  
 2 Arrow: Diamond grade film #3990 white  
 3 Arrow Circle: Paint black MAP #78A-1A jet black  
 4 Background: Paint black MAP #78A-1A jet black  
 5 Text: Diamond grade film #3990 white

**GRAPHICS:** N/A

**ARROWS:** 10"

**MOUNTING:** Post mounted.

**ILLUMINATION:** Sign will be Non Illuminated.

**Directional Signs - Secondary** **3.5.1**



#	Revision	Date

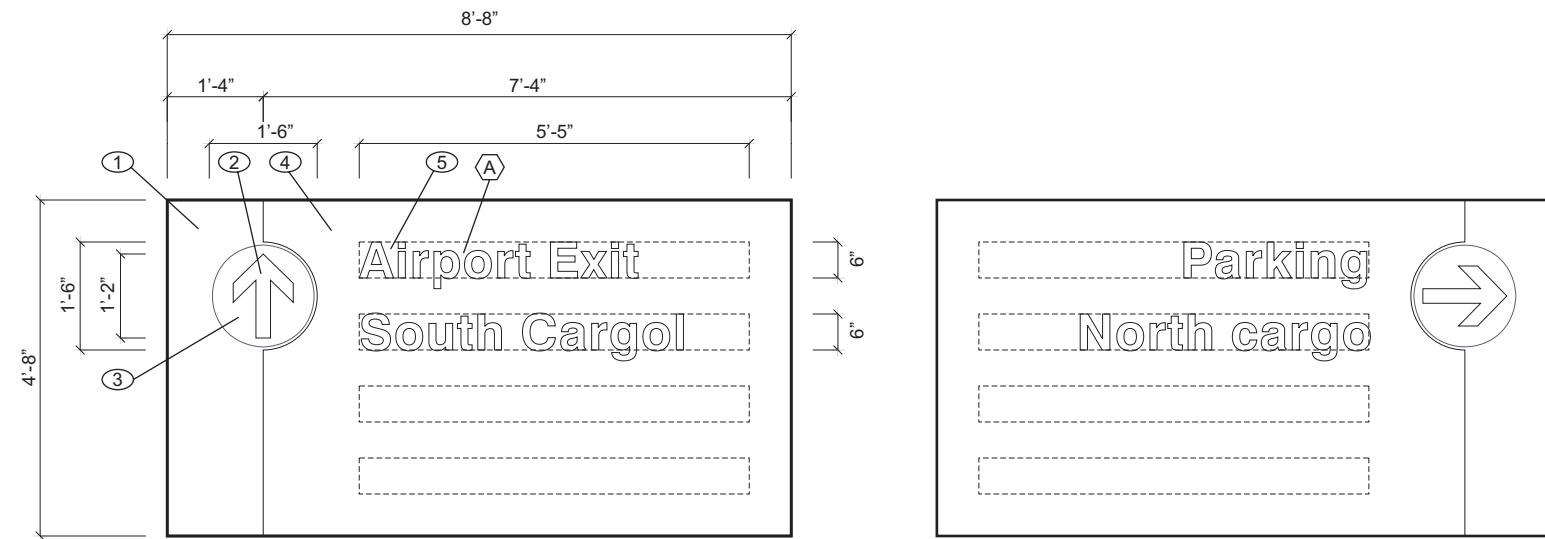

SIGN FACE LAYOUT  
Scale: 3/16" = 1'-0"

**Directional - Roadside** **ST - 413**

**DESCRIPTION:** Roadside Directional - 2 panels  
**LOCATION:** Roadside perpendicular to vehicular traffic.

**MATERIALS:** Aluminum sign face with reflective vinyl.

**LETTERING:**  
 Ⓐ Swiss721 BT Bold  
 Ⓑ N/A

**SYMBOLGY:** (Refer to Section 2.2.2)

- COLORS:**
- ① Band: Paint color to match dark grey #425C
  - ② Arrow: Diamond grade film #3990 white
  - ③ Arrow Circle: Paint black MAP #78A-1A jet black
  - ④ Background: Paint black MAP #78A-1A jet black
  - ⑤ Text: Diamond grade film #3990 white

**GRAPHICS:** N/A

**ARROWS:** 10"

**MOUNTING:** Post mounted.

**ILLUMINATION:** Sign will be Non Illuminated.

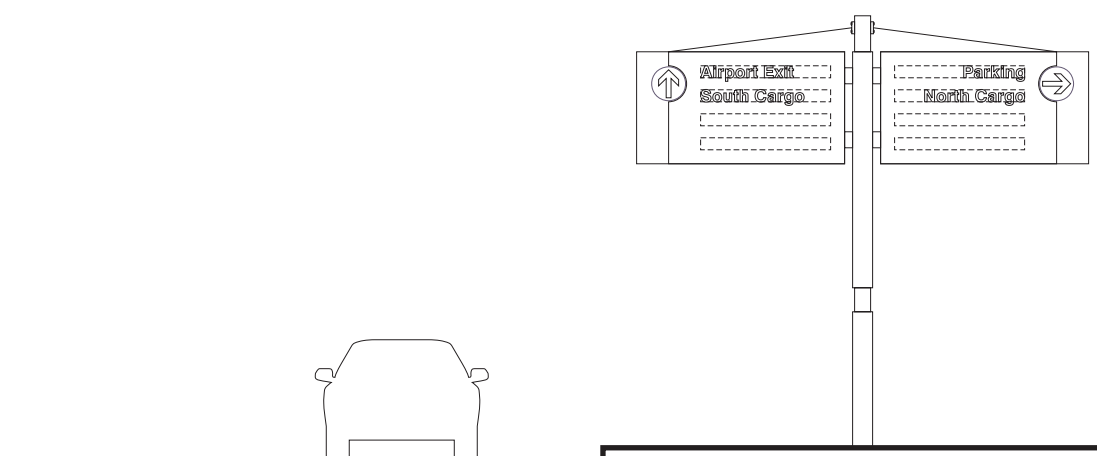

ELEVATION  
Scale: 1/8" = 1'-0"

Note: See page 3-40 for attachment methods.